

Elephant

Neuland Industriedesign

Generous and light, accommodating and dynamic, the Elephant chair marks a working partnership between Neuland studio and Kristalia. The basic version is available in hard polyurethane in various colours, with a 4-leg base or slide base with a chrome or satin finish, or in the same colour lacquer.

Metal finish:

- Polished chrome steel
- Satin-finish chrome steel
- Steel with lacquer in a colour to match the seat

Body finish:

- White polyurethane (PO1)
- Black polyurethane (PO3)
- Beige polyurethane (PO4)
- Terracotta brown polyurethane (PO6)
- Brown polyurethane (PO7)
- Olive green polyurethane (PO8)



Suitable for outdoor use (painted version).

Armchair with legs

Code	Body	Metal finish	Vol.
05ELE11	polyurethane	lacquered steel	0.39
		polished chrome steel	
		satin steel	

1 armchair in each package

Armchair on a slide frame

Code	Body	Metal finish	Vol.
05ELE12	polyurethane	lacquered steel	0.39
		polished chrome steel	
		satin steel	

1 armchair in each package

Optionals

Code	Description	Vol. ²
20ELE01	Black 007 fabric SCUBA (Kvadrat®)	0.02
	Beige 002 fabric SCUBA (Kvadrat®)	
	Terracotta brown 023 fabric SCUBA (Kvadrat®)	
	Brown 025 fabric SCUBA (Kvadrat®)	
	Olive green 012 fabric SCUBA (Kvadrat®)	

1 cushion in each package

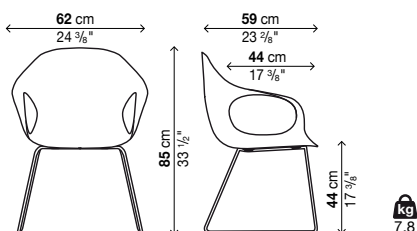
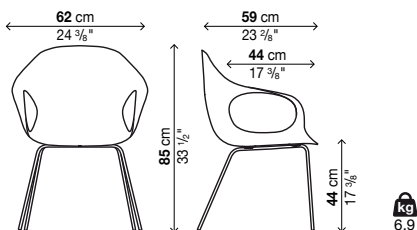
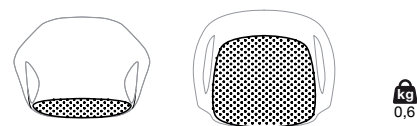

SEATS CAN BE DELIVERED READY-TO-ASSEMBLE ON REQUEST:

- (V. m³)
- x 4 = 0,25
- x 4 = 0,19
- x 4 = 0,25

Elephant in hide

Neuland Industriedesign

The padded version with cold-foamed polyurethane cushions upholstered in hide is even more refined and comfortable, with handcrafted stitching, which recalls the backbone of an elephant, adding a further touch of natural prestige to the concept of this chair.

Metal finish:

- Polished chrome steel
- Satin-finish chrome steel
- Steel with white lacquer
- Steel with black lacquer

Finish of cover:

- Hide (C1 → C12)
- “Full-grain” hide (natural or black)

Armchair with legs

Code	Upholstery for body	Metal finish	Vol.
05ELE01	hide C1 → C12	lacquered steel	0.39
		polished chrome steel	
		satin steel	
05ELE01	“full-grain” hide	lacquered steel	0.39
		polished chrome steel	
		satin steel	

1 armchair in each package

Armchair on a slide frame

Code	Upholstery for body	Metal finish	Vol.
05ELE02	hide C1 → C12	lacquered steel	0.39
		polished chrome steel	
		satin steel	
05ELE02	“full-grain” hide	lacquered steel	0.39
		polished chrome steel	
		satin steel	

1 armchair in each package

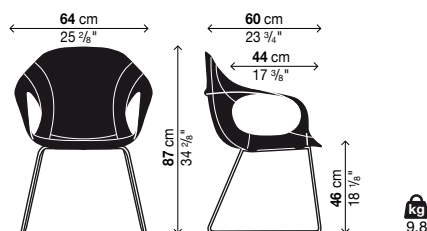
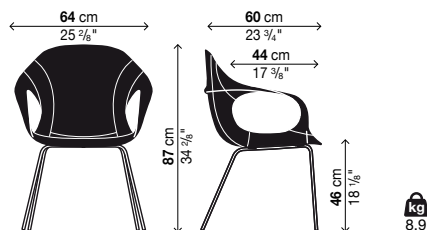

Elephant on wooden base

Neuland Industriedesign

2011 sees the new version of Elephant with typical Nordic style solid beech legs.

Base finish:

Solid beech

Solid beech lacquered in shade matching the chair

Body finish:

White polyurethane (PO1)

Black polyurethane (PO3)

Beige polyurethane (PO4)

Terracotta brown polyurethane (PO6)

Brown polyurethane (PO7)

Olive green polyurethane (PO8)

Code	Body	Base finish	Vol.
05ELE82	polyurethane	beech wood colour to match the seat	0.36

1 armchair in each package

Removable cushion

Code	Description	Vol.
20ELE01	Black 007 fabric SCUBA (Kvadrat®)	0.02
	Beige 002 fabric SCUBA (Kvadrat®)	
	Terracotta brown 023 fabric SCUBA (Kvadrat®)	
	Brown 025 fabric SCUBA (Kvadrat®)	
	Olive green 012 fabric SCUBA (Kvadrat®)	

1 cushion in each package

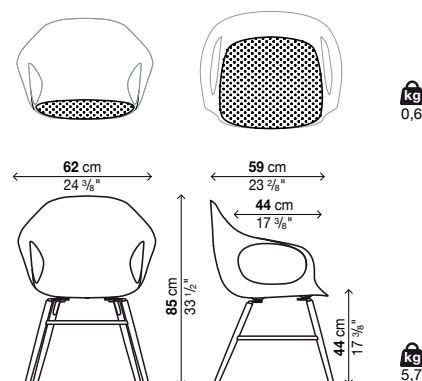

SEATS CAN BE DELIVERED READY-TO-ASSEMBLE ON REQUEST:

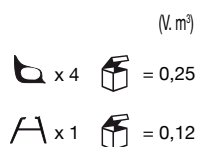

Elephant in hide on wooden base

Neuland Industriedesign

The padded version with cold-foamed polyurethane cushions upholstered in hide is even more refined and comfortable, with handcrafted stitching, which recalls the backbone of an elephant, adding a further touch of natural prestige to the concept of this chair.

Base finish:

Solid beech

Solid beech with white lacquer

Solid beech with black lacquer

Finish of cover:

Hide (C1 → C12)

“Full-grain” hide (natural or black)

Code	Upholstery for body	Base finish	Vol.
05ELE81	hide C1 → C12	beech wood lacquered wood	0.36

05ELE81	“full-grain” hide	beech wood lacquered wood	0.36
----------------	-------------------	------------------------------	------

1 armchair in each package

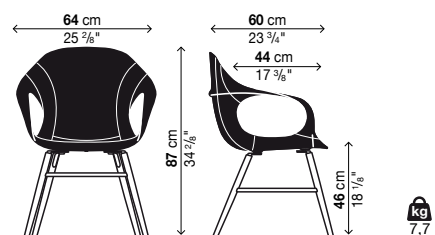

Elephant on trestle

Neuland Industriedesign

2011 sees the new version of Elephant with polished or painted die-cast aluminium swivel base.

Metal finish:

Polished aluminium

Aluminium with lacquer in a colour to match the seat

Body finish:

White polyurethane (PO1)

Black polyurethane (PO3)

Beige polyurethane (PO4)

Terracotta brown polyurethane (PO6)

Brown polyurethane (PO7)

Olive green polyurethane (PO8)

Code	Body	Metal finish	Vol.
05ELE72	polyurethane	polished aluminium	0.47
		Aluminium with lacquer	

1 armchair in each package

Removable cushion

Code	Description	Vol.
20ELE01	Black 007 fabric SCUBA (Kvadrat®)	0.02
	Beige 002 fabric SCUBA (Kvadrat®)	
	Terracotta brown 023 fabric SCUBA (Kvadrat®)	
	Brown 025 fabric SCUBA (Kvadrat®)	
	Olive green 012 fabric SCUBA (Kvadrat®)	

1 cushion in each package

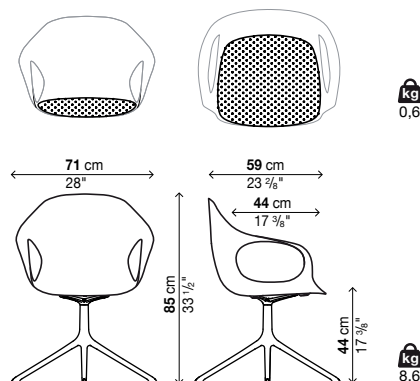

SEATS CAN BE DELIVERED READY-TO-ASSEMBLE ON REQUEST:

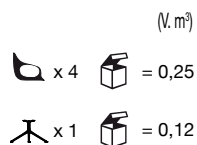

Elephant in hide on trestle

Neuland Industriedesign

The padded version with cold-foamed polyurethane cushions upholstered in hide is even more refined and comfortable, with handcrafted stitching, which recalls the backbone of an elephant, adding a further touch of natural prestige to the concept of this chair.

Metal finish:

Polished aluminium

Aluminium with white lacquer

Aluminium with black lacquer

Finish of cover:

Hide (C1 → C12)

“Full-grain” hide (natural or black)

Code	Upholstery for body	Metal finish	Vol.
05ELE71	hide C1 → C12	polished aluminium	0.47
		Aluminium with lacquer	

05ELE71	“full-grain” hide	polished aluminium	0.47
		Aluminium with lacquer	

1 armchair in each package

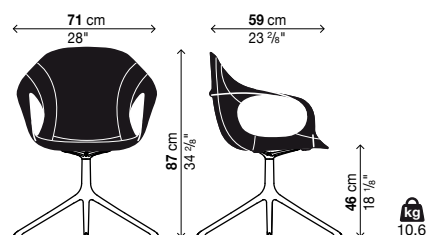

Finishes

Finiture metallo

Metal finish / Metallausführungen / Acabados metal / Finitions métal



Alluminio lucidato / Polished aluminium / Aluminium glänzend /
Aluminio pulido / Aluminium poli



Acciaio cromato / Polished chrome steel / Stahl glänzend
verchromt / Acero cromado / Acier chromé



Acciaio cromo satinato / Satin-finish chrome steel /
Gebürsteter Chromstahl Stahl / Acero cromo satinado / Acier
chromée satinée



Bianco / White / Weiß / Blanco / Blanc



Nero / Black / Schwarz / Negro / Noir



Beige / Beige / Beige / Beige / Beige



Terracotta / Terracotta / Tonerde / Terracota / Terre cuite

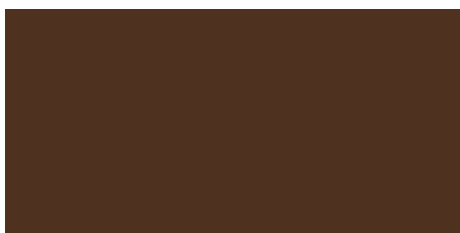

Marrone / Brown / Braun / Marrón / Marron



Verde oliva / Olive-green / Olivengruen / Verde oliva /
Olive vert

Finishes

Essenze legno

Wood finishes / Holzarten / Esencias de madera / Essences du bois



Faggio / Beech / Buchenholz / Haya / Hêtre

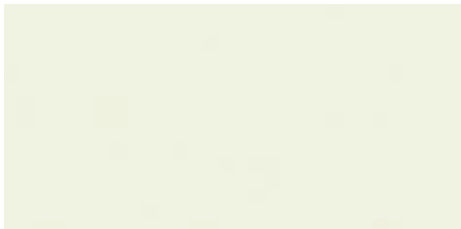

Bianco / White / Weiß / Blanco / Blanc

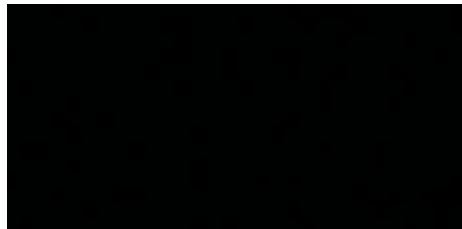

Nero / Black / Schwarz / Negro / Noir

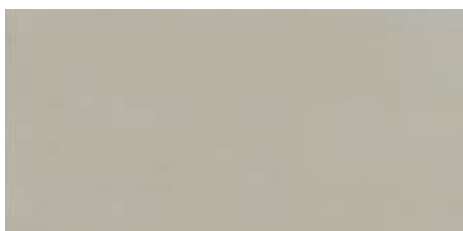

Beige / Beige / Beige / Beige / Beige



Terracotta / Terracotta / Tonerde / Terracota / Terre cuite

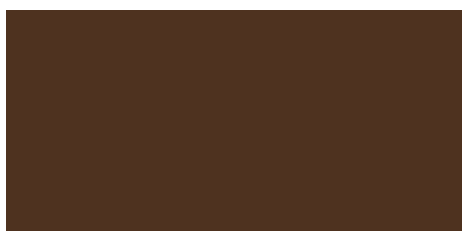

Marrone / Brown / Braun / Marrón / Marron



Verde oliva / Olive-green / Olivengruen / Verde oliva / Olive vert

Finiture poliuretano

Polyurethane finish / Ausführung Polyurethan / Acabados poliuretano / Finitions polyuréthane

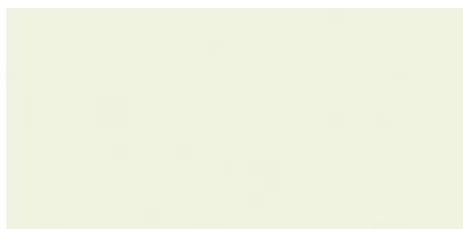

PO1 Bianco / White / Weiß / Blanco / Blanc

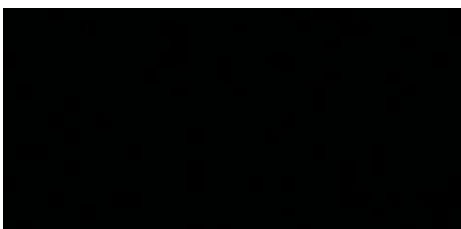

PO3 Nero / Black / Schwarz / Negro / Noir

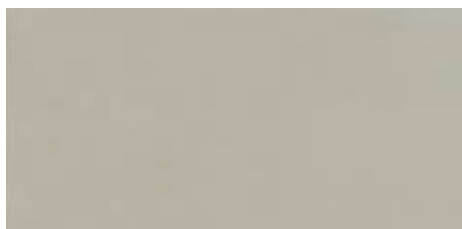

PO4 Beige / Beige / Beige / Beige / Beige

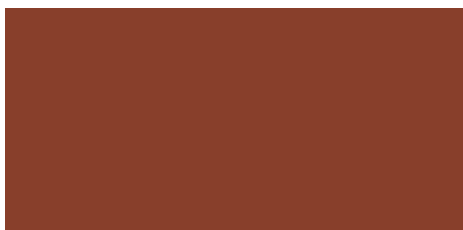

PO6 Terracotta / Terracotta / Tonerde / Terracota / Terre cuite

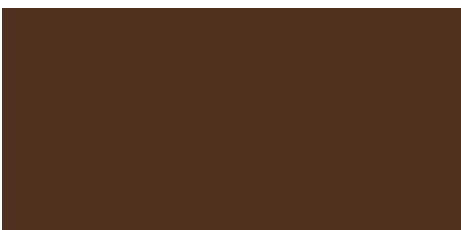

PO7 Marrone / Brown / Braun / Marrón / Marron



PO8 Verde oliva / Olive-green / Olivengruen / Verde oliva / Olive vert

Finishes

Finiture cuoio

Hide finishes / Ausführungen Kernleder / Acabados cuero / Finitions cuir

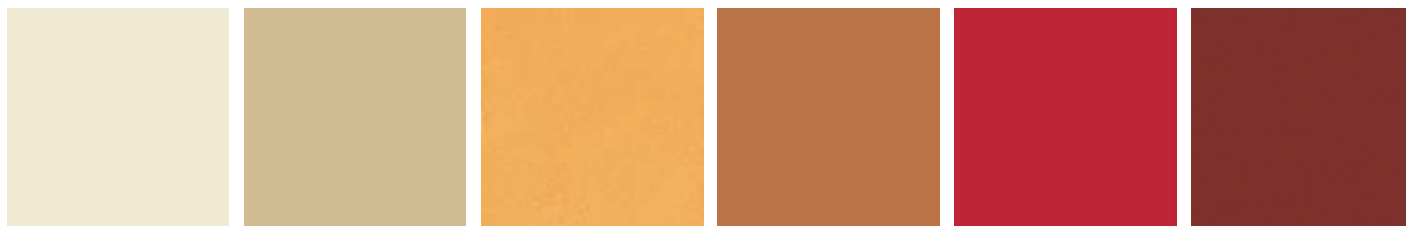

C1

C2

C3

C4

C5

C6



C7

C8

C9

C10

C11

C12

Finiture cuoio "pieno fiore"

"Full-grain" hide finishes / Ausführungen des "vollnarbigen" Leders / Acabados cuero "plena flor" / Finitions Cuir "pleine fleur"

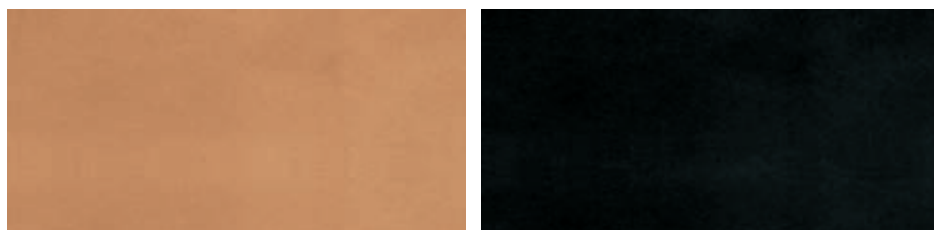

F1 Naturale / Natural / Natur / Natural / Naturel

F2 Nero / Black / Schwarz / Negro / Noir