SAKé

SOFAS

Piero Lissoni



Description

SAKé signals the beginning of Piero Lissoni's collaboration with B&B Italia. The design begins from a strongly contemporary seating system distinguished by a careful search for formal balance. Seats in three sizes (cm 175, 210 and 270), with embracing or linear backs and arms of various dimensions added harmoniously to create a sofa adapted to the customer's space and personal taste. The system is enhanced with a chaise longue element (cm 105 x 135) that lends itself to various interpretations: as the terminal element in a linear composition, with a more enveloping back and with the addition of armrests, it can stand on its own or, alongside another chaise lounge, it can create a sofa with deep seating. The details of the cushions and support base contribute to the design lightness. The seat cushion has refined modular stitching, ranging from cm 35 or cm 45; the back cushions, available in two sizes, are outlined by profiled bands. The seating system support base is made of crosspiece with rounded steel feet connected to each other by a bar. All this is finished in pewter painted colour. This seating system also offers a

sofa bed (cm 150 x 210), the only one in the B&B Italia collection, adopting the other sofas seating and back elements. The interchangeable right or left armrest can serve as a headboard when, with a simple translation movement of the seat and the overturning of the back, the sofa becomes a single bed.

Technical information

Internal frame

tubular steel and steel profiles

Seat, back and armrest upholstery

Bayfit® (Bayer®) flexible cold shaped polyurethane foam, polyester fibre cover

Internal frame (sofa bed)

multi-layered wood panel

Seat and back upholstery (sofa bed)

shaped polyurethane of different density, polyester fibre cover

Back cushion (SK50C-SK75C-SK90C)

combination of polyester fibre and visco-elastic polyurethane, polyester fibre cover, box style typology

Support frame

steel

Ferrules

thermoplastic material

Cover

fabric or leather

Technical drawings

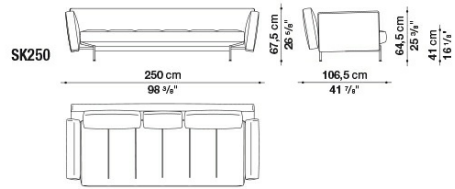

SK250

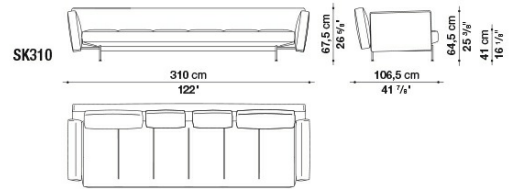

SK310

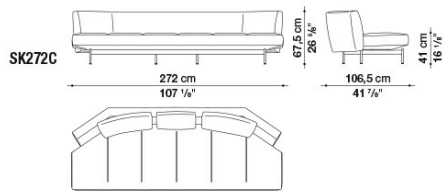

SK272C

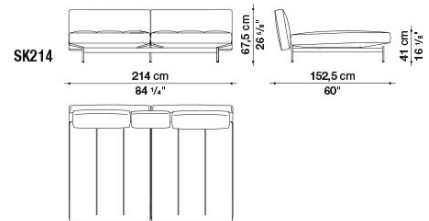

SK214

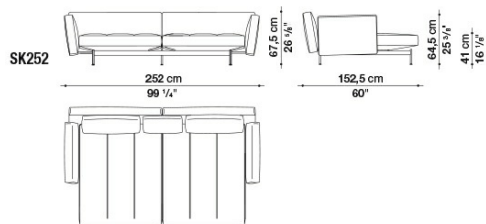

SK252

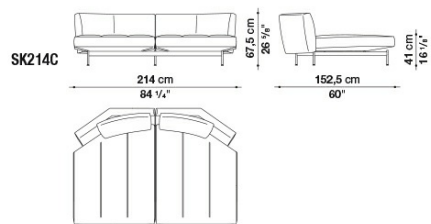

SK214C

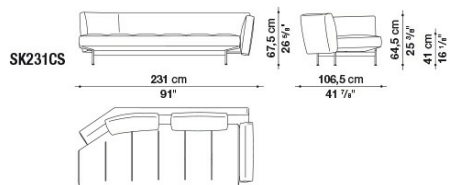

SK231CS

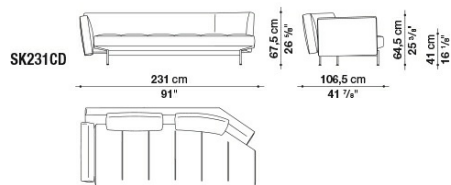

SK231CD

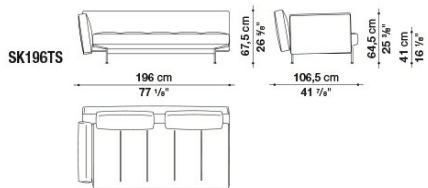

SK196TS

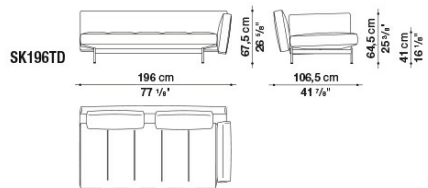

SK196TD

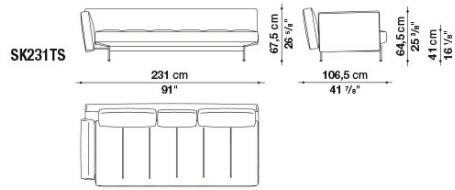

SK231TS

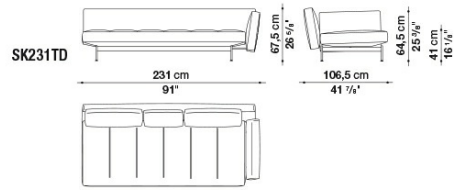

SK231TD

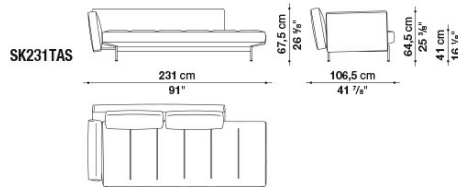

SK231TAS

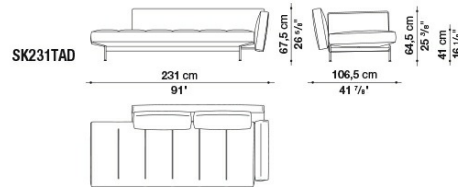

SK231TAD

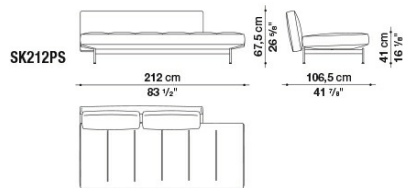

SK212PS

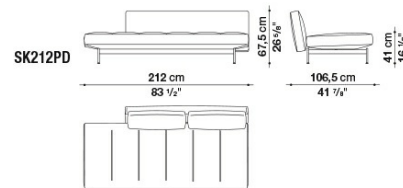

SK212PD

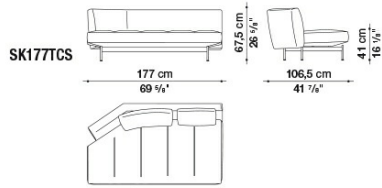

SK177TCS

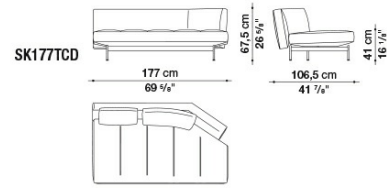

SK177TCD

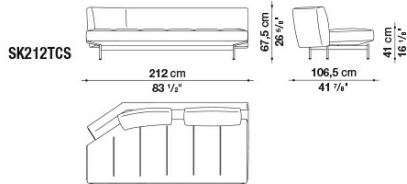

SK212TCS

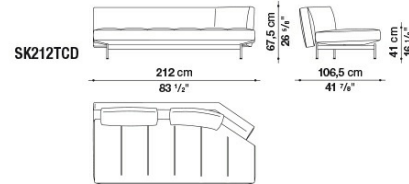

SK212TCD

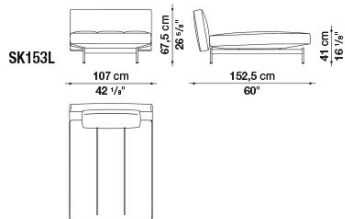

SK153L

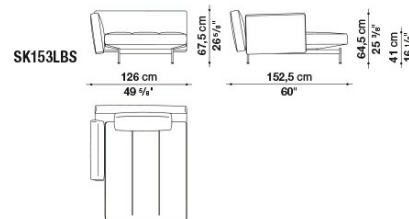

SK153LBS

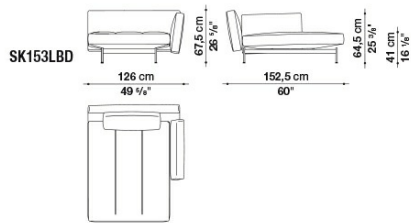

SK153LBD

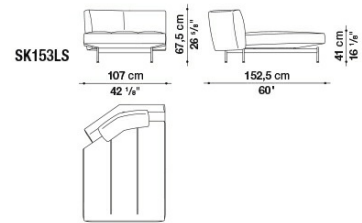

SK153LS

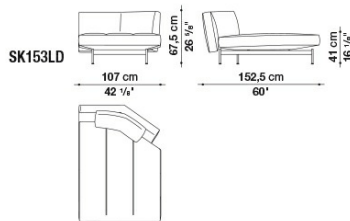

SK153LD

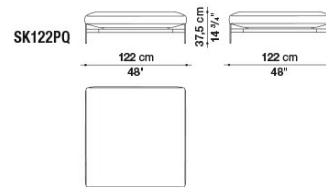

SK122PQ

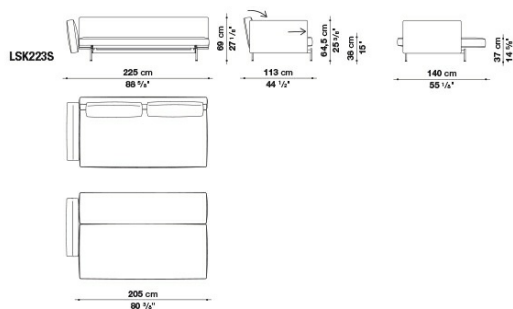

LSK223S

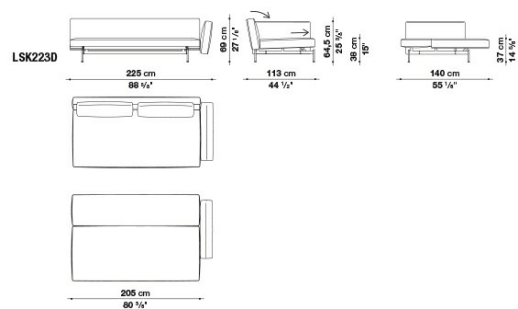

LSK223D

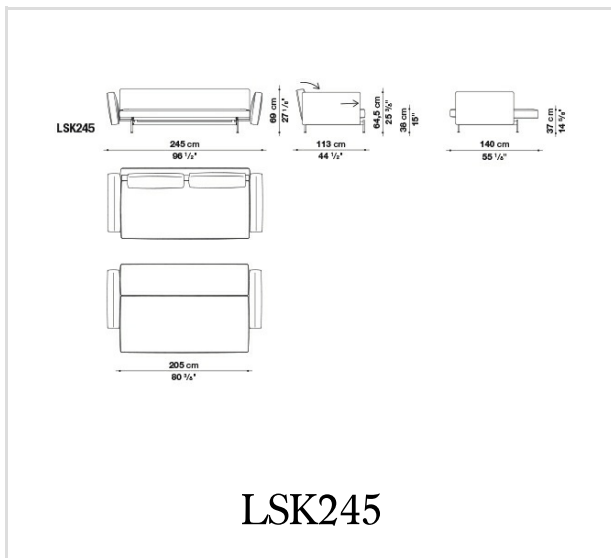

B&B Italia reserves the right to make technological and aesthetic improvements to its models, including changes to the sizes and materials, without notice. The technical drawings do not define the details of the product. The measurements shown are indicative and may undergo changes. In particular, the dimensions relevant to the padded parts are subject to usage tolerances over time caused by the normal adjustment of the padding. For the specific information, please contact the dealer closest to you.