



LAURENT 09



type	suspension
materials	sphere: handblown opaline glass frame: polished brass or powder coated aluminum or nickel plated steel hardware: polished brass or powder coated aluminum wire: nylon/polyester
weight	9 lb / 4 kg
light bulb	LED (included), 4,5W (see lightbulb section for specifications)
sockets	G9
voltage	120V / 240V
dimmer	refer to our recommended list of dimmer models
certifications	 
notes	<ul style="list-style-type: none"> - must be installed by an electrician - additional charges for modifications or for special orders - lead time between 8 to 9 weeks. - dimensions are approximate and may vary slightly.

parallel wires

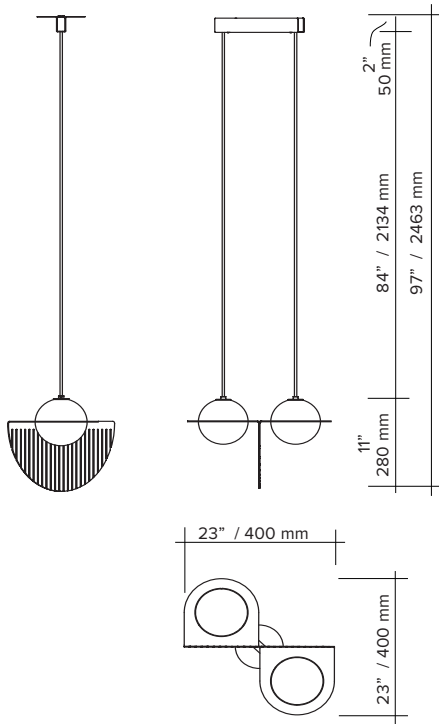

parallel wires with offset connection

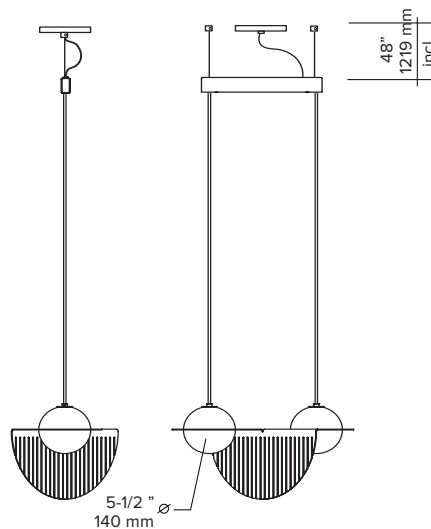

angled wires

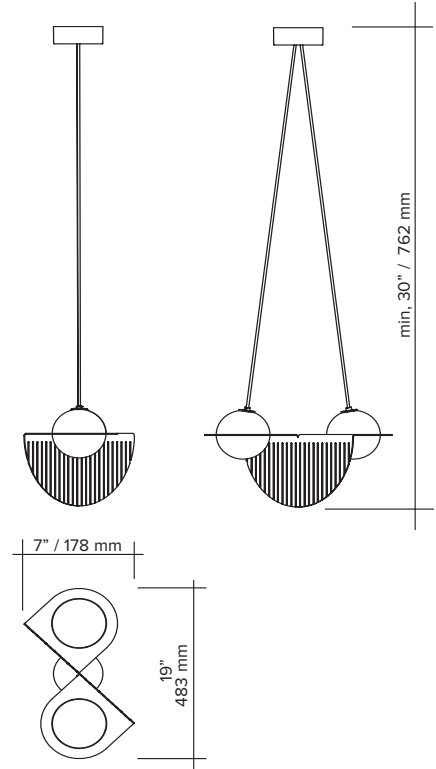

ORDER GUIDE: SKU

COLLECTION	MODEL	COLOUR (frame + wire system)	CANOPY	MOUNTING TYPE
LRT Laurent	09	BLBL black + black BRBL brass + black BRGD brass + gold CHBL chrome + black CHBE chrome + blue BEBL blue + black BEBE blue + blue BUBL burgundy + black BUSA burgundy + sand BUBU burgundy + burgundy TUBL turquoise + black TUSA turquoise + sand	BL black	AW angled wires PW parallel wires
LRT	09	BLBL	BL	AW

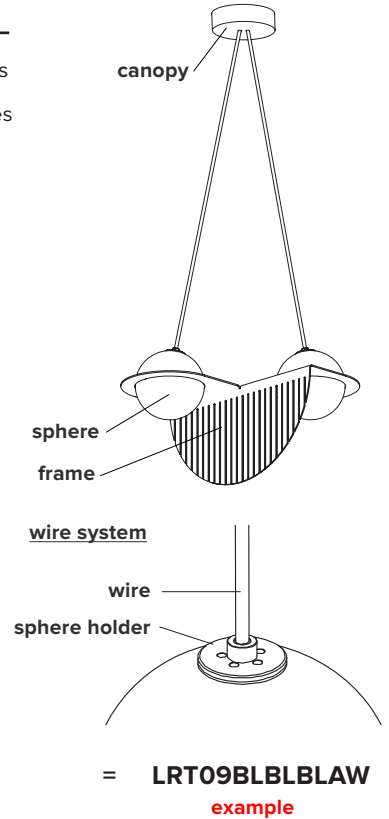

FRAME COLOUR

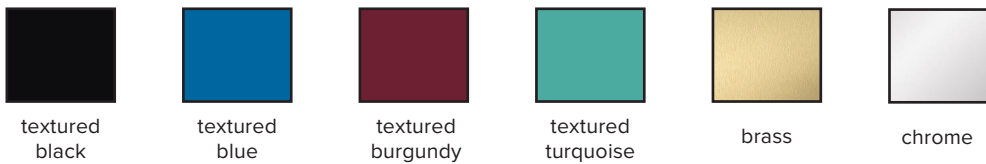

MOUNTING COLOUR sphere holder & wires

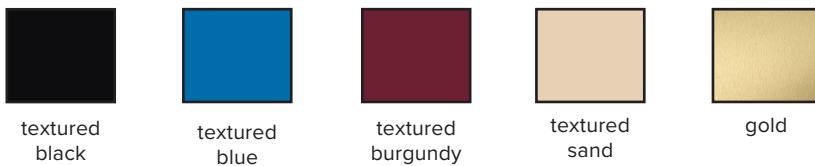

CANOPY COLOR custom color available on demand

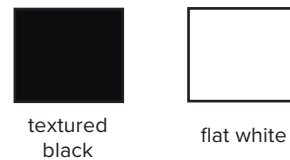

MOUNTING TYPE

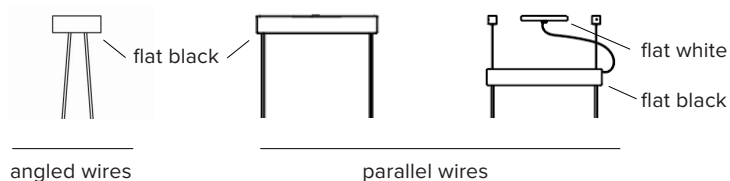

LIGHT BULB & DIMMER SPECIFICATIONS

G9 SOCKETS

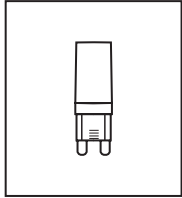

Frosted
4.5W
100V-120V / 240V
450 Lumens
2700 K
25 000 H
CRI ≥80
2 years warranty

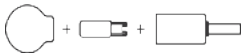

DIMMER LIST COMPATIBILITY FOR G9 LED BULBS – 120V

The dimming technology offering the best results is ELV (electronic low voltage) dimmers with reverse phase or trailing edge control.

<u>DIMMER BRAND</u>	<u>MODEL NUMBER</u>	<u>MAX LEVEL</u>	<u>MIN LEVEL</u>	<u>FLICKERING</u>	<u>OVERALL QUOTE</u>
LUTRON - MAESTRO	MAELV-600	100%	0%	0%-10%	good
LUTRON - SKYLARK	SELV-300P	100%	0%	no	very good
LUTRON - SKYLARK	SELV-303P	100%	0%	no	very good
LUTRON - SKYLARK	CTELV-303P	100%	0%	no	very good
LUTRON - DIVA	DVELV-300P	100%	0%	no	very good
LEGRAND - ADORNE	TRUE UNIVERSAL	100%	30%	no	good

DIMMER LIST COMPATIBILITY FOR G9 LED BULBS – 230V

<u>DIMMER BRAND</u>	<u>MODEL NUMBER</u>	<u>MAX LEVEL</u>	<u>MIN LEVEL</u>	<u>FLICKERING</u>	<u>OVERALL QUOTE</u>
VARILIGHT	V-PRO	100%	2%	no	very good
LEGRAND - NILOÉ	3 996 35	87%	15%	no	good
NIKO	310-0280X	94%	5%	no	very good
NIKO	310-0190X	100%	1%	no	very good

*Other dimmers can yield good results and we recommend conducting your own test before final installation.