



Suita Sofa

The Suita Sofa system combines light and slender volumes with an industrial and technological aesthetic. The geometrically precise body and cushions seem to float above the sleek, bridge-like aluminium legs, which can be seen as a tribute to mid-century American design. The Suita Sofa family consists of many individual components. These can be used as independent elements or freely combined to adapt to all kinds of interior environments and furnishing needs.

The seat and back cushions are available in firm or soft versions.

The Suita Sofa comes in two- and three-seat models with closed ends as well as open versions with a single armrest on the left or right, which can be combined with chaises longues in various widths and lengths.

Materials

- **Legs:** die-cast aluminium, polished or powder-coated.
- **Body:** webbed metal frame with moulded polyurethane foam.
- **Firm seat cushions:** polyurethane foam and polyester fibre.

- **Soft seat cushions:** chamber cushions filled with polyurethane chips and feathers, with polyurethane foam core.
- **Classic back cushions:** chamber cushions filled with polyurethane chips and feathers.
- **Covers:** removable.
- **Filling for pointed cushions 40 x 40 cm:** 100% feathers.
- **Filling for pointed cushions 40 x 60 cm:** 100% feathers.
- **Filling for pointed cushions 60 x 60 cm:** polyurethane chips and feathers.
- **Filling for pointed cushions 60 x 80 cm:** polyurethane chips and feathers.
- **Filling for bolsters:** polyurethane chips and feathers.

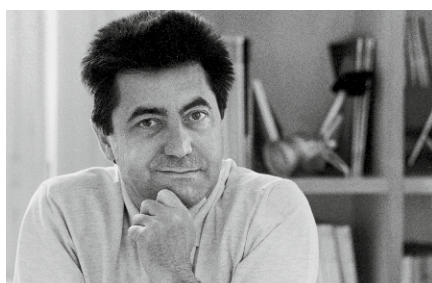

Antonio Citterio

The architect and designer Antonio Citterio, who lives and works in Milan, has collaborated with Vitra since 1988. Together they have produced a series of office chairs and various office systems, as well as products for the Vitra Home Collection. The Citterio Collection is constantly being expanded.

1	Suita	12-13	Accessories, legs & frame	20-21	Useful facts
2-5	Configurations	14-16	Cover materials	22-24	Configurations and dimensions
6-7	Types of upholstery and comfort	17-19	Suita pointed cushions, Maharam pillows	25-29	Dimensions
8-11	Suita family			30-32	Surfaces and colours

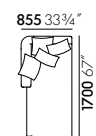

Suita Chaise Longue small, soft upholstery, Corsaro fabric (01 pale blue melange), pointed cushions

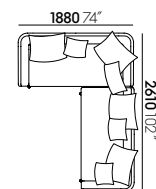

Suita Sofa Two-Seater and Suita Sofa Two-Seater open, soft upholstery, Over fabric (01 ivory), pointed cushions

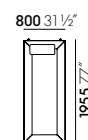

Suita Daybed and Suita Sofa Two-Seater, soft upholstery, Cosy fabric with contrast stitching (01 pebble grey), pointed cushions
 Suita Fauteuil Ottoman, Cosy fabric with contrast stitching (01 pebble grey)

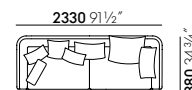

Suita Sofa Three-Seater, soft upholstery, Cosy fabric with contrast stitching (o2 fossil)

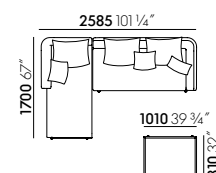

Suita Chaise Longue small, Suita Sofa Two-Seater open and Suita Ottoman, soft upholstery, Corsaro fabric (o2 dark brown melange), pointed cushions

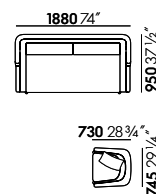

Suita Sofa Two-Seater with head section, firm upholstery, Credo fabric (16 red chili), classic cushions
Suita Club Armchair, Credo fabric (16 red chili)

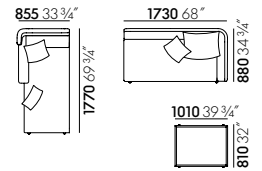

Suita Chaise Longue small with head section, Suita Sofa Two-Seater open, Suita Fauteuil Ottoman, firm upholstery, Dumet fabric (04 brown melange), classic cushions

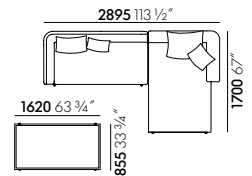

Suita Sofa Two-Seater open, Suita Chaise Longue wide and Suita Platform, firm upholstery, Corsaro fabric (04 dark blue melange)

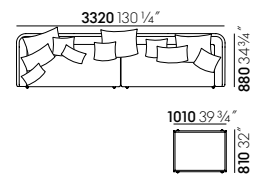

Two Suita Sofa Two-Seaters open and a Suita Ottoman, soft upholstery, Dumet fabric (05 sand/anthracite), pointed cushions

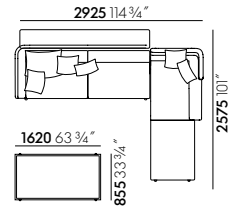

Suita Sofa Three-Seater open and back shelf, Suita Chaise Longue large with head section and Suita Platform with Slipcover, soft upholstery, Olimpo fabric (03 bamboo), pointed cushions

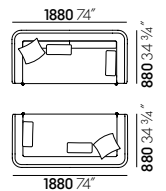

Two Suita Sofa Two-Seaters, firm upholstery, Premium leather (75 camel), classic cushions

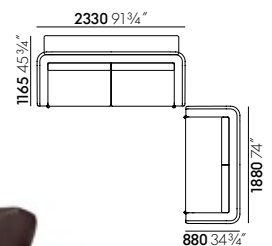

Suita Sofa Three-Seater and Suita Sofa Two-Seater, firm upholstery, Natural leather (68 chocolate), classic cushions and pointed cushions

The elegant Suita Sofa family encompasses a wide range of elements that can be freely combined with one another. A choice of different cushion types augments the adaptability of this system to fulfil personal needs and preferences.

The sleek body, consisting of a tubular steel frame covered in moulded polyurethane foam with web suspension, forms the basis of all Suita models. It can be fitted with firmly upholstered seat cushions or, alternatively, soft reversible cushions.

Back cushions are available in two different shapes:



CLASSIC CUSHIONS

Elegant shape with large back cushions, linear contours, formal appearance, available with firm or soft padding.

POINTED CUSHIONS

Casual, soft shape with inviting comfort, for relaxed seating or reclining.

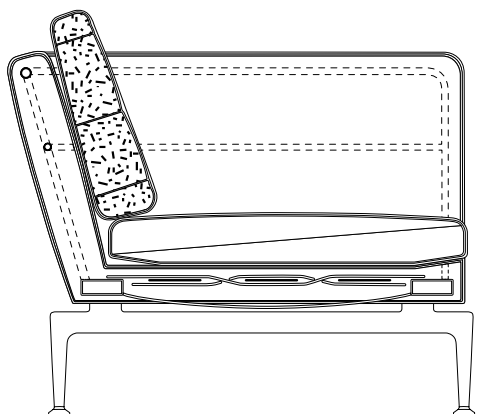

FIRM SEAT UPHOLSTERY AND FIRM CLASSIC CUSHIONS

The firm upholstery version provides resilient support, yielding only partially to the weight of the sitter. Its firm padding makes it easy to sit down and stand up.

The seat cushion comprises various foam layers, referred to as a sandwich construction. It is softer towards the back and firmer in front, thus providing enhanced support for the sitter.

The back cushions have a chamber cushion structure filled with a mixture of feathers and polyurethane rods.

The crisp appearance of the firm upholstery elements is characterised by linear, geometric forms.

Firm upholstery versions are available with covers in fabric or leather.

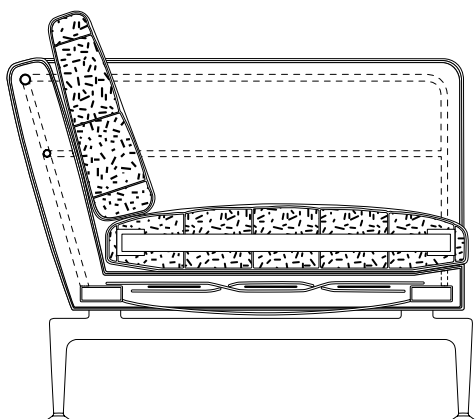

SOFT SEAT UPHOLSTERY AND SOFT CLASSIC AND POINTED CUSHIONS

The soft upholstery is distinguished by its soft appearance and supple comfort. It allows the sitter to sink into the cushioning more deeply than the firm upholstery version and creates an inviting place to lounge and relax.

The seat upholstery consists of a polyurethane foam core surrounded by a chamber cushion structure filled with a mixture of feathers and polyurethane rods.

The large classic back cushion has a chamber structure containing a blend of feathers and polyurethane rods.

The stitched pointed cushions are filled with a mixture of feathers and polyurethane chips.

The appearance of the soft upholstery elements conveys a feeling of cosy comfort. The cover material is loosely fitted with gentle folds.

The soft upholstered version only comes with fabric covers. Firm upholstery versions are available with covers in fabric or leather.

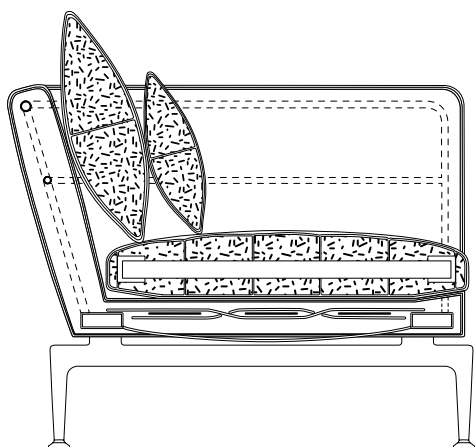



Two-Seater



Two-Seater open

The Suita Sofa comes in two- and three-seat models with closed ends as well as open versions with a single armrest on the left or

right, which can be combined with chaises longues in various widths and lengths.



Three-Seater



Three-Seater open

- **Legs:** die-cast aluminium, polished or powder-coated.
- **Body:** webbed metal frame with moulded polyurethane foam.
- **Firm seat cushions:** polyurethane foam and polyester fibre.
- **Soft seat cushions:** chamber cushions filled with polyurethane chips

and feathers, with polyurethane foam core.

- **Classic back cushions:** chamber cushions filled with polyurethane chips and feathers.
- **Covers:** removable.



The Suita Club Armchair can be combined with all other members of the Suita Sofa family. With its elegantly understated design, the armchair cuts a fine figure on its own or as a companion piece for a wide variety of sofas. The Suita Club Armchair is generously upholstered and extremely comfortable without the need for additional cushions.

- **Legs:** die-cast aluminium, polished or powder-coated.
- **Body:** moulded polyurethane foam with webbed metal frame.
- **Seat cushion:** polyurethane foam and polyester fibre.



Chaise Longue small



Chaise Longue wide



Chaise Longue large

The Chaises Longues of the Suita family are available in three sizes: small, large and wide. They can be ideally combined with single-armrest Suita Sofa models, but also make a striking solo piece.

- **Legs:** die-cast aluminium, polished or powder-coated.
- **Body:** webbed metal frame with moulded polyurethane foam.
- **Firm seat cushions:** polyurethane foam and polyester fibre.
- **Soft seat cushions:** chamber cushions filled with polyurethane chips and feathers, with polyurethane foam core.
- **Classic back cushions:** chamber cushions filled with polyurethane chips and feathers.
- **Covers:** removable.



Suita Daybed is an elegant lounger in firm or soft versions with a classic neck roll cushion.

- **Legs:** die-cast aluminium, polished or powder-coated.
- **Daybed:** metal frame with wooden panel, polyurethane foam.
- **Firm seat cushion:** polyurethane foam and polyester fibre.
- **Soft seat cushion:** chamber cushion filled with polyurethane chips and feathers, with polyurethane foam core.



Suita Platforms can serve a dual function as a tautly upholstered seat or as a coffee table. With printed or plain slipcovers, the Platforms are available in square and rectangular versions.

- **Legs:** die-cast aluminium, polished or powder-coated.
- **Platform:** wooden panel, polyurethane foam and polyester fibre.



The Suita Ottoman is also available in soft or firm versions. As a companion piece, it can be freely positioned around the Sofa, allowing users to enjoy the latter's full comfort.

- **Legs:** die-cast aluminium, polished or powder-coated.
- **Ottoman:** wooden board, polyurethane foam, seat cushion.

Added to a freestanding Suita Sofa, the rear-mounted shelf makes a perfect temporary workspace in combination with a laptop and a chair. Positioned against the wall, the shelf offers a convenient additional surface for storage and display. And a head section fitted to the sofa not only provides extra support, but also helps to block out noise and visual stimuli.

- **Head section:** moulded polyurethane foam with metal frame.
- **Shelf:** aluminium profile, powder-coated die-cast zinc with linoleum inlay.

Shelves

Suita Two- and Three-Seater Sofas in both the closed and open versions can be fitted with a shelf with a linoleum inlay. Shelf bases are available in the colours soft light and basic dark.



Head section

Both two- and three-seat models of the Suita Sofa can be fitted with a headrest extension. The head section is available in all cover materials.

All versions of the Suita Chaise Longue can be equipped with a head section, available in all cover materials.

Headrest cushions offer enhanced comfort.



The structural body of Suita rests on bridge-like legs. Shelf and headrest elements are also mounted on the legs. The Suita Sofa has a comfortable seat height of 25 cm. The aluminium legs and frame have a polished finish or are alternatively available with a powder-coated finish in soft light or basic dark.



Polished aluminium

Suita configuration featuring Two-Seater Sofa open, Chaise Longue large with headsection and Platform 1600 x 855 cm in Over fabric (o2 camel) with frame and legs in polished aluminium. Shelf in soft light with linoleum inlay (o3 peat).



Powder-coated in soft light

Suita configuration featuring Two-Seater Sofa open, Chaise Longue large with headsection and Platform 1600 x 855 cm in Over fabric (o1 ivory) with frame and legs in powder-coated aluminium with soft light finish. Shelf in soft light with linoleum inlay (o1 pebble).



Powder-coated in basic dark

Suita configuration featuring Two-Seater Sofa open, Chaise Longue large with headsection and Platform 1600 x 855 cm in Over fabric (o5 slate) with frame and legs in powder-coated aluminium with basic dark finish. Shelf in basic dark with linoleum inlay (o2 charcoal).



Crede

95% new wool, 5% polyamide | 640 gr/m²

Crede is a durable woollen fabric made of premium worsted yarn with a pleasant feel. The two- and three-tone colours give this resilient fabric a characteristic structure and vibrant appearance. Crede allows for an effective exchange of heat to ensure comfortable thermal conditions for the sitter. The fabric can also be used in office environments.

Crede is available in 12 colours.



Cosy

80% new wool, 20% polyamide | 450 gr/m²

Cosy is an exclusive woollen cloth with a natural, Nordic-inspired character. The subtly variegated colours and coordinated contrast stitching produce a refined visual effect. The visible fibres enhance the natural appearance. Cosy optimises the transfer of heat, which provides pleasant thermal conditions for the sitter.

Cosy is available in 10 colours.

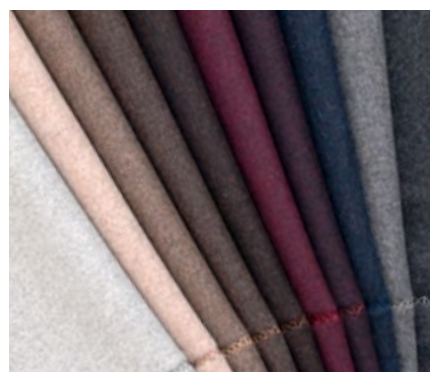

Dumet

46% cotton, 22% viscose, 22% wool, 10% linen | 485 gr/m²

Dumet is a cotton blend with a lively appearance. The mixed tones create an elegant look with an Italian flair. Dumet is soft and cool to the touch.

Dumet is available in 17 colours.



Corsaro

46% polyacrylic, 20% wool, 14% polyester, 10% cotton, 5% linen, 5% nylon | 450 gr/m²

Corsaro features a sophisticated combination of fine and coarse yarns with an Italian flair. The two- and three-tone colours combined with the bouclé yarn add vibrancy to larger upholstered surfaces.

Corsaro is available in 6 colours.

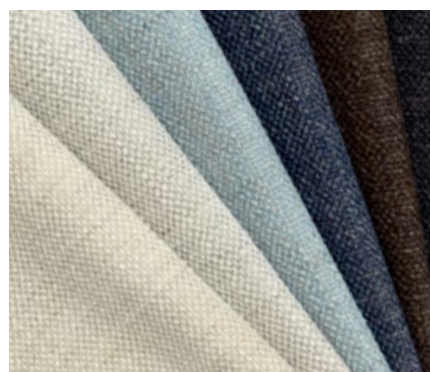

**Olimpo**

70% linen, 30% viscose | 520 gr/m²

The typical linen structure of Olimpo has a fine, natural look. The fabric's high percentage of linen, clearly evident to the touch, results in comfortably cool conditions for the sitter. The viscose content makes Olimpo very robust and abrasion-resistant.

Olimpo is available in 10 colours.

**Over**

60% viscose, 21% linen, 19% cotton
| 710 gr/m²

Over is a medium-weight cover fabric with an elegant woven texture and subtle sheen. The linen content is perceptible to the touch and ensures comfortably cool conditions for the sitter.

Over is available in 9 colours.

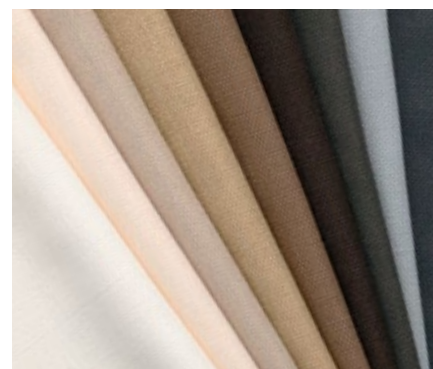
**Laser**

100% Trevira CS polyester | 520 gr/m²

Laser is a robust and striking cover fabric with a distinctive woven structure. Easy to care for and durable like sportswear, the fabric is also highly abrasion-resistant. The economical Laser fabric can also be utilised in office environments.

Laser is available in 14 colours.





Leather

1.1-1.3 mm thick, pigmented leather

The standard grade leather used by Vitra is a robust calf leather, dyed-through, pigmented and embossed with an even grain pattern. Hard-wearing and easy to maintain, it is also well suited for office environments. Available in 7 colours.

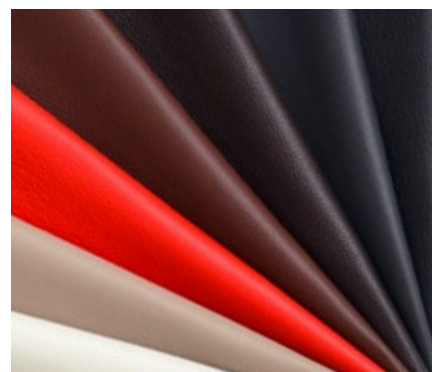

Premium leather

1.1-1.3 mm thick, semi-aniline leather

Premium leather is a smoother calf leather with a flat grain and fine top sheen. It is dyed-through and lightly pigmented. The semi-aniline leather is soft to the touch, like glove leather. Premium leather is available in 11 colours.

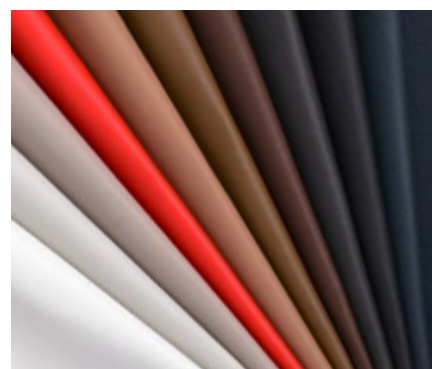

Grand leather

1.5-1.7 mm thick, semi-aniline leather

Grand leather is a strong and robust calf leather with a natural, distinct texture (milled grain). It is dyed-through and lightly pigmented (semi-aniline leather). Grand leather is voluminous, robust and warm to the touch. Grand leather is available in 5 colours.

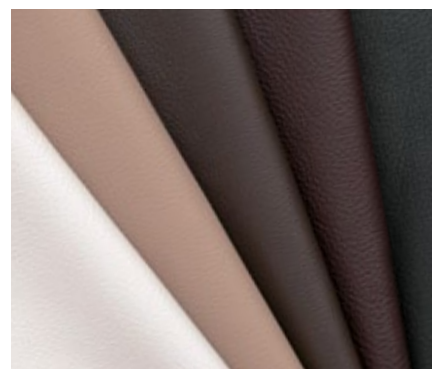

Natural leather

1.3-1.5 mm thick, aniline leather

Natural leather is a very soft, fine calf leather with a naturalistic appearance due to the genuine grain texture. It is porous, breathable and warm to the touch. Through use, Natural leather takes on a lively, characteristic patina. Natural leather is available in 3 colours.

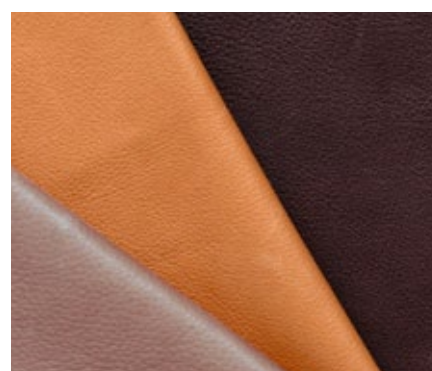



The Suita Sofa offers a choice of soft or firm cushions in a classic shape as well as pointed cushions in various sizes. The latter are available in solid colours or with printed motifs by Alexander Girard.

- **Pointed cushions 40 x 40 cm:** 100% feathers.
- **Pointed cushions 40 x 60 cm:** 100% feathers.
- **Pointed cushions 60 x 60 cm:** polyurethane chips and feathers.
- **Pointed cushions 60 x 80 cm:** polyurethane chips and feathers.
- **Bolsters:** polyurethane chips and feathers.

SELECTION OF POINTED CUSHIONS

Suita Sofas, Chaises Longues and the Daybed can be ordered with pointed cushions. The table below indicates the standard sizes and number of cushions provided with the respective furniture models. Additional pointed cushions may be ordered separately.



Pointed cushion sets	80 x 60 cm	60 x 60 cm	60 x 40 cm	40 x 40 cm	54 x 16 cm
Two-Seater	1x	1x	1x	1x	
Three-Seater	1x	2x	1x	1x	
Chaise Longue small and large		1x	1x	1x	
Chaise Longue wide	1x		1x		
Daybed				1x	1x

SUITA POINTED CUSHIONS (PRINTED)

vitra.

Alexander Girard (1907-1993)

Together with his colleagues Charles and Ray Eames and George Nelson, Alexander Girard was one of the leading figures in American design during the postwar era. His passion for colours, patterns and textures found expression in the field of textile design, which was a focal part of his oeuvre. With their colourful patterns, his textiles are as fresh and contemporary as when they were first introduced over fifty years ago. Girard's designs lend a sensuous playfulness to modern furnishings. Complemented by pillows featuring his motifs, the Suita Sofa acquires a warm and individual expressiveness. The printed cushions are covered with Olimpo fabric in the colours pearl or sandstone.



Love, 40 x 40 cm



Sun, 40 x 40 cm



Snake, 60 x 60 cm



Geometri D, 60 x 40 cm



Retrospective Repeat,
60 x 60 cm



Square Diamonds,
80 x 60 cm



Love, 40 x 40 cm



Sun, 40 x 40 cm



Snake, 60 x 60 cm



Geometri D, 60 x 40 cm



Retrospective Repeat,
60 x 60 cm



Square Diamonds,
80 x 60 cm

Hella Jongerius, 2013

The New York textile company Maharam produces fabrics of the highest quality. The collection of decorative pillows by Dutch designer Hella Jongerius revitalises historical designs found in company archives using new colours and combinations. The pillows are beautifully coordinated and can also be attractively paired with other pillows and fabrics.

Filling/covers: duck down, fabrics by Maharam, New York



Vases Sprout, 55 x 55 cm



Vases Sprout, 40 x 40 cm



Vases Berry, 55 x 55 cm



Vases Berry, 40 x 40 cm



Vases Goldenrod,
55 x 55 cm



Vases Goldenrod,
40 x 40 cm



Vases Shelter,
55 x 55 cm



Vases Shelter,
40 x 40 cm



Vineyard Woven Cay,
55 x 55 cm



Vineyard Woven Cay,
40 x 40 cm



Park Woven Bamboo/Lichen,
55 x 55 cm



Park Woven Bamboo/Lichen,
40 x 40 cm



Park Woven Cayenne/Syrah,
55 x 55 cm



Park Woven Cayenne/Syrah,
40 x 40 cm



Colorwheel Pumice,
55 x 55 cm



Colorwheel Pumice,
40 x 40 cm



Vineyard small Ochre/White,
30 x 40 cm



Layers Park Earth/Cobalt,
30 x 40 cm



Layers Park Poppy/Melon,
30 x 40 cm



Vineyard small Jade/Turquoise,
30 x 40 cm



Repeat classic Houndstooth,
Lemon, 30 x 40 cm



Repeat classic Houndstooth,
Cocoa 30 x 40 cm



Repeat classic Houndstooth,
Pine 30 x 40 cm



Repeat classic Houndstooth,
Moss 30 x 40 cm

Vitra has over fifty years of experience in the production of upholstered furniture. Premium materials, skilled craftsmanship and high quality standards at Vitra are a guarantee for long-lasting products. In Vitra's own test centre, our upholstered furnishings are regularly subjected to a wide range of tests that far exceed common standards.

Care instructions:

Exposure to direct sunlight should be avoided whenever possible, since intensive radiation can cause cover materials to fade.

To retain the original fullness and shape of your sofa, cushions should be regularly shaken and plumped.

Folds and creases from sitting can be prevented in all types of upholstery by smoothing the cover material after use.

USEFUL FACTS ABOUT COVER MATERIALS

Covers have a decisive influence on the appearance and characteristics of upholstered furniture. Along with the type of material, weave and aesthetic features of the textile, a major role is played by technical properties such as resistance to abrasion, fading or stains.

Function and performance are primarily determined by the type of fabric used. In general, synthetic fibres are superior to natural fibres in terms of their technical characteristics. For this reason, blends of different materials are employed to combine the advantages of the individual fibres.

In the following, you will find some of the key features of the textiles used by Vitra in its upholstery covers:

Cotton (CO)

Skin-friendly natural fibre of plant origin, comfortable to the touch, readily absorbs moisture. Often inferior to synthetic fibres with regard to colourfastness and light resistance, flat weaves susceptible to pilling.

Linen (LI)

Natural fibre of plant origin with slight lustre, cool and comfortable, repels dirt, no pilling. Limited colourfastness to light and crocking, creases easily.

Wool (WO)

Elastic natural fibre of animal origin, naturally self-cleaning – a brief airing disperses absorbed odours, leaving the wool smelling neutral and fresh again. Good resistance to light and abrasion, highly absorbent, minimal creasing, low flammability. Subject to pilling and matting.

Polyester (PE), Polyacrylic (PA), Viscose (VI)

Synthetic, highly uniform, lightfast fibres. The non-absorbent properties of synthetics can be mitigated with fibre blends and weaving techniques.

The overall look of a piece of furniture is influenced by the colour and type of cover fabric, its properties (elastic or non-stretch) as well as the upholstery technique (removable or attached covers). Consequently, a sofa can take on a different appearance depending on the cover material. Generally speaking, cover fabrics with some elasticity are less susceptible to creases and puckering, since they have an adaptable fit on three-dimensional forms. Heavier cover materials such as Over, Laser or Credo drape more smoothly while thinner materials exhibit a finer rippling effect.

Care instructions:

All Suita covers are removable. Fabric covers can be taken to a professional cleaner. Prior to treatment, please be sure to note the composition of the cover fabric and follow care instructions.

Should you ever need to replace individual parts or covers due to wear and tear, please contact your local Vitra retailer.

The products developed by Vitra in collaboration with internationally renowned designers are distinguished by excellent quality and great longevity. Based on the criteria of durability, warmth and comfort, high-quality leather is superior to almost any other material.

Leather is a robust natural product with an individual character that lends a timeless elegance to furnishings.

The quality of leather depends, in part, on the animals themselves: their breed, age and gender, their geographical origins and respective climate conditions. Vitra exclusively uses leather sourced from animals in Scandinavia and Central Europe. Scars, sting marks and scratches are normal characteristics of leather that highlight its natural appearance. Vitra utilises only the best hides.

Another factor that influences the quality of leather is the tanning of the skins. Tanning is the name of the process used to turn cowhide into leather. The art of tanning requires the same skill and attention to detail as it has for centuries: before the selected salt-cured skins are ready for tanning, they must be soaked in water and the hair must be removed. The valuable outer skin is fleshed and cleaned before the actual tanning process begins. The skins are soaked in large, rotating vats filled with tanning agents obtained from plants, minerals or synthetic compounds, which are absorbed by the fibres to make the leather soft and durable.

Vitra uses leather in three different qualities:

**Pigmented leather
(Leather)**

Leather in standard quality is pigmented. It is especially robust and offers outstanding economical value. Highly resistant to both UV radiation and abrasion, its appearance and physical properties change very little over a long period of time. The top side of the skin is sanded, pigmented with an opaque surface colour and embossed with an even grain pattern. Pigmented leather is simple to care for and also easy to clean.

**Semi-aniline leather
(Leather Premium / Leather Grand)**

Vitra's Premium and Grand leathers are both semi-aniline leathers mainly distinguished by differences in their grain textures. Premium leather has a silky, smooth-grained surface, while the grain pattern of Grand leather is more pronounced. This is achieved in a milling process which makes the skin more pliable and gives added volume to the grain. Semi-aniline leather is dyed through with a lightly pigmented finishing layer. Premium and Grand leathers are a good choice for connoisseurs who value durability but also desire the soft, warm feel of natural leather. The beauty of this leather evolves with use, so that the upholstery acquires its typical patina as the years go by.

**Aniline leather
(Leather Natural)**

Vitra's Natural leather is a pure aniline leather. It is dyed without a pigmented surface coating, making it less resistant to light but fully retaining its natural appearance. Only a minimal protective surface finish is applied. The natural processing of aniline leather gives it maximum breathability and a silky, soft feel. Careful treatment preserves the beauty of this exquisite cover material and lends it an appealing, individual patina.

Care instructions:

Furniture with leather upholstery should not be positioned in close proximity to heat sources, which can cause leather to dry out and become brittle. We also recommend that leather upholstery be protected from permanent exposure to direct sunlight, since intensive radiation can diminish the quality of leather and cause it to fade over time.

For occasional cleaning, add flakes of a hard neutral soap to distilled water and stir until frothy. Moisten a soft cloth (do not use microfibre cloth) and wipe gently over the leather surface, leaving it slightly damp. The ingredients in the soapy liquid remove dust and dirt, while also supplying the leather with needed conditioners.

Liquid spills should be immediately dabbed dry and wiped off with a little water (do not use microfibre cloth).

Small soiled spots can be removed with a colourless rubber (eraser).

Once a year, the leather should be treated with a special leather care product; never use aggressive cleaning agents. Please refer to the leather care instructions provided with your sofa.

Additional information on leather care can be found at: www.lck-international.com.

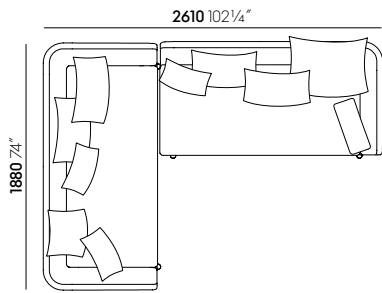

Suita Sofa Two-Seater, Suita Sofa Two-Seater open

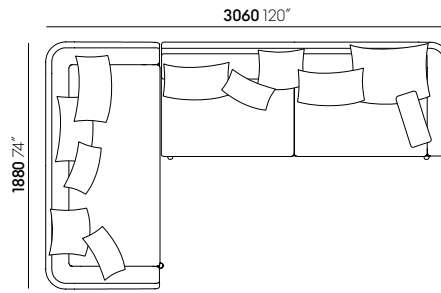

Suita Sofa Two-Seater, Suita Sofa Three-Seater open

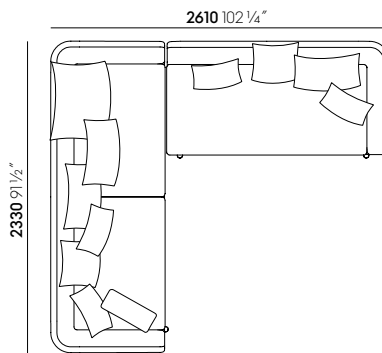

Suita Sofa Three-Seater, Suita Sofa Two-Seater open

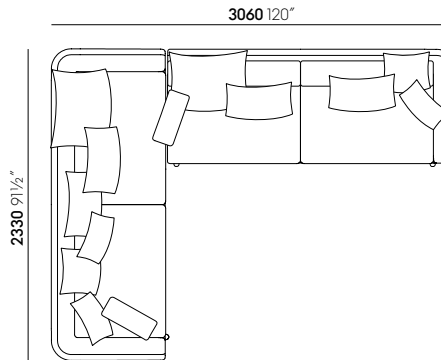

Suita Sofa Three-Seater, Suita Sofa Three-Seater open

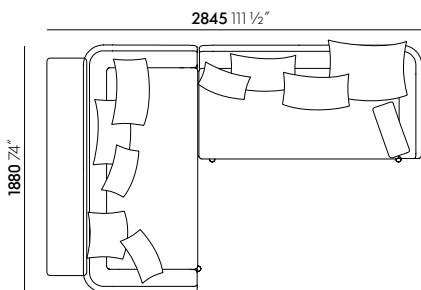

Suita Sofa Two-Seater with shelf, Suita Sofa Two-Seater open

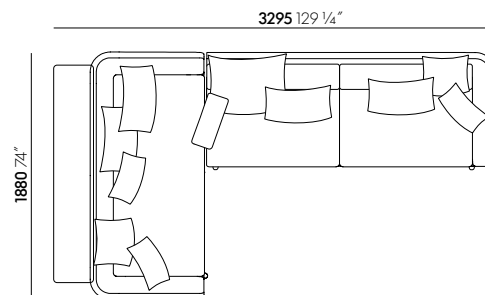

Suita Sofa Two-Seater with shelf, Suita Sofa Three-Seater open

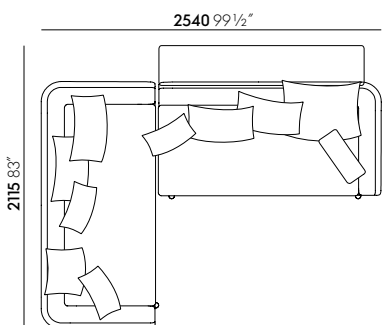

Suita Sofa Two-Seater, Suita Sofa Two-Seater open with shelf

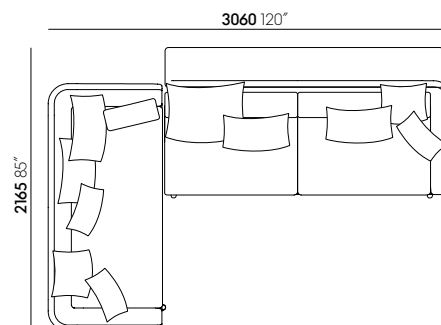

Suita Sofa Two-Seater, Suita Sofa Three-Seater open with shelf

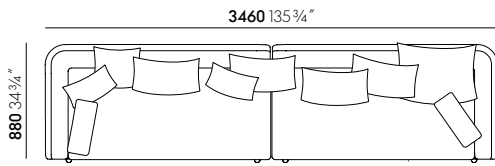

Suita Sofa Two-Seater open right, Suita Sofa Two-Seater open left

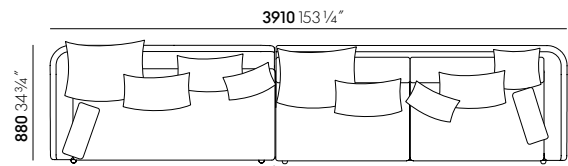

Suita Sofa Two-Seater open right, Suita Sofa Three-Seater open left

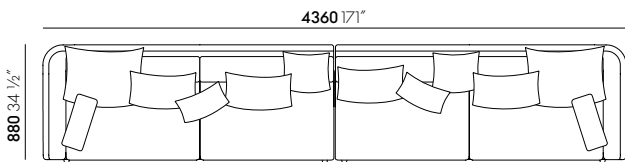

Suita Sofa Three-Seater open right, Suita Sofa Three-Seater open left

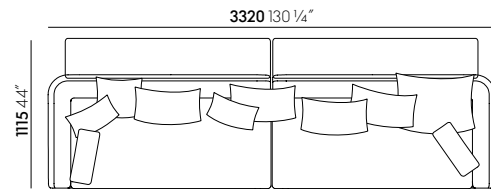

Suita Sofa Two-Seater open right, Suita Sofa Two-Seater open left, both with shelf

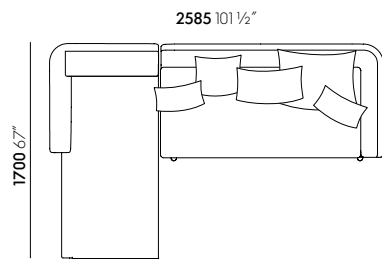

Suita Chaise Longue small, Suita Sofa Two-Seater open

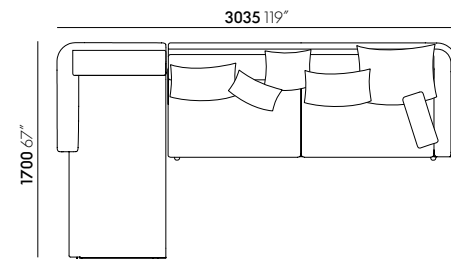

Suita Chaise Longue small, Suita Sofa Three-Seater open

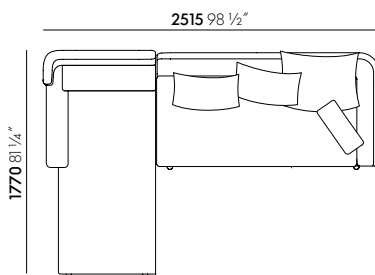

Suita Chaise Longue small with head section, Suita Sofa Two-Seater open

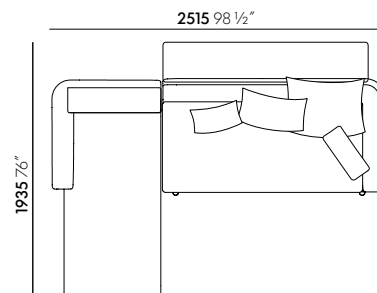

Suita Chaise Longue small, Suita Sofa Two-Seater open with shelf

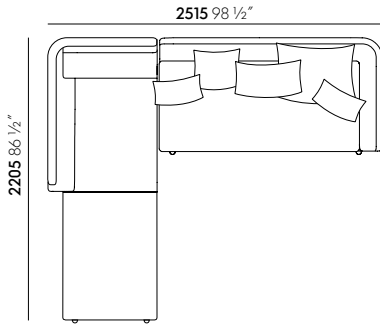

Suita Chaise Longue large, Suita Sofa Two-Seater open

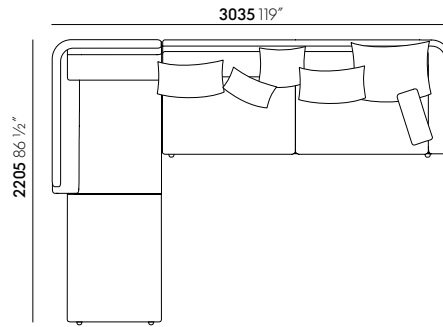

Suita Chaise Longue large, Suita Sofa Three-Seater open

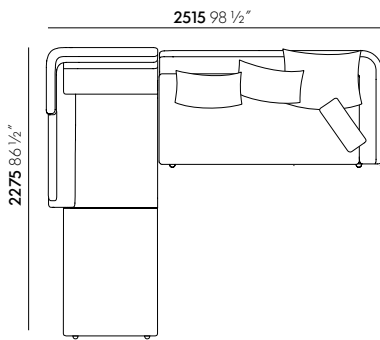

Suita Chaise Longue large with head section, Suita Sofa Two-Seater open

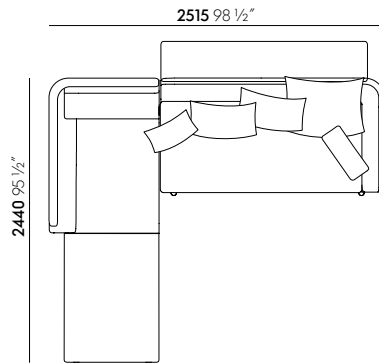

Suita Chaise Longue large, Suita Sofa Two-Seater open shelf

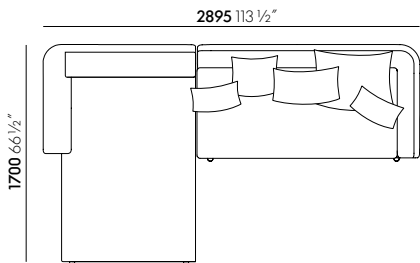

Suita Chaise Longue wide, Suita Sofa Two-Seater open

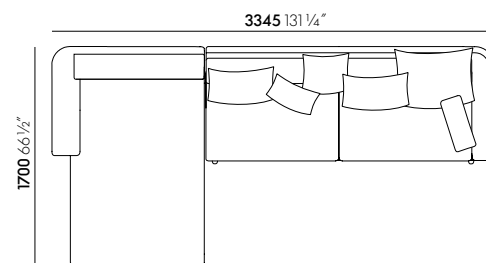

Suita Chaise Longue wide, Suita Sofa Three-Seater open

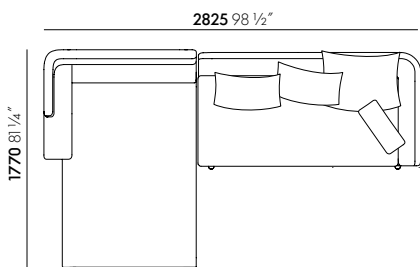

Suita Chaise Longue wide with head section, Suita Sofa Two-Seater open

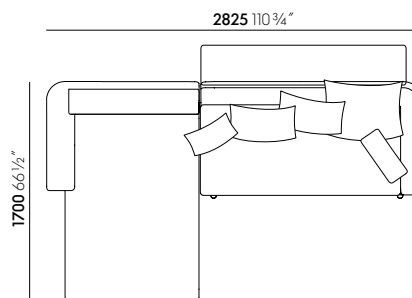

Suita Chaise Longue wide, Suita Sofa Two-Seater open with shelf

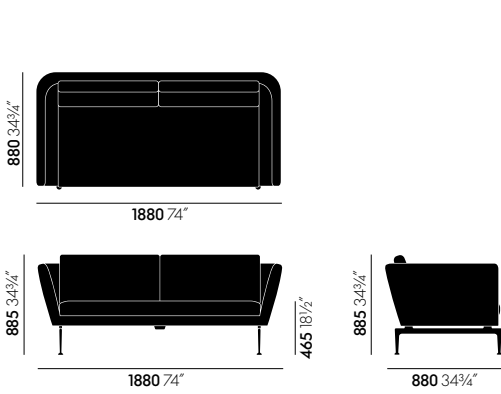

Suita Sofa Two-Seater

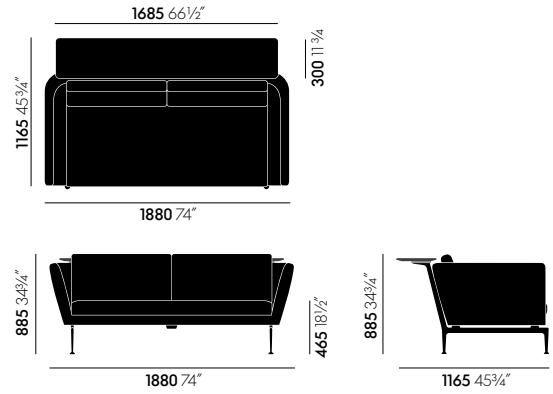

Suita Sofa Two-Seater with shelf

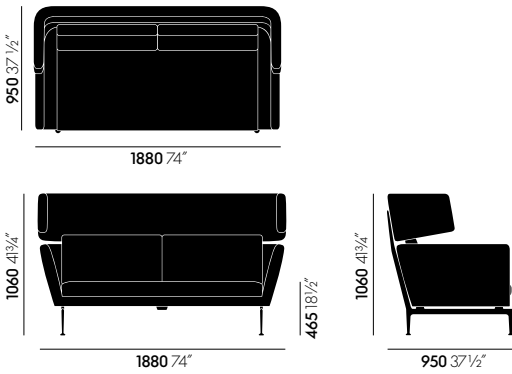

Suita Sofa Two-Seater with head section

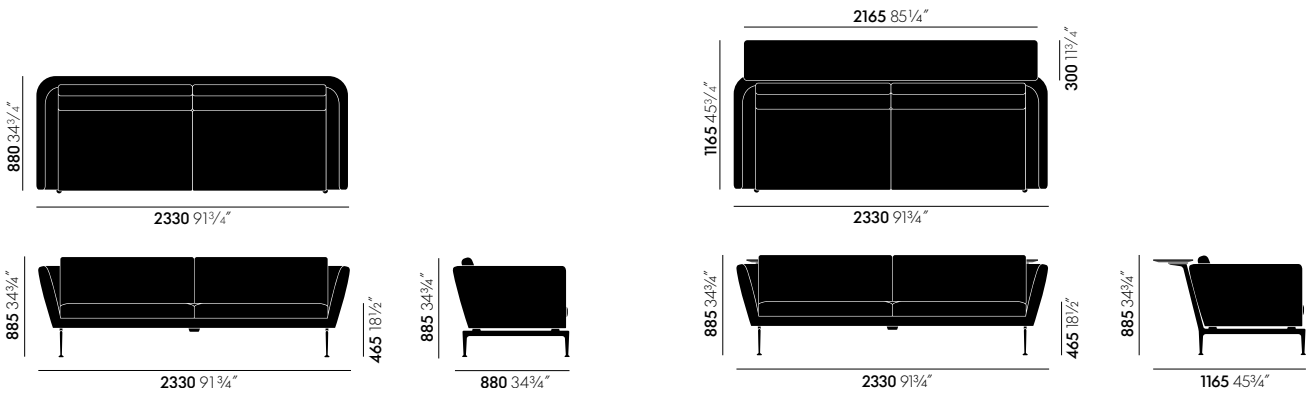

Suita Sofa Three-Seater

Suita Sofa Three-Seater with shelf

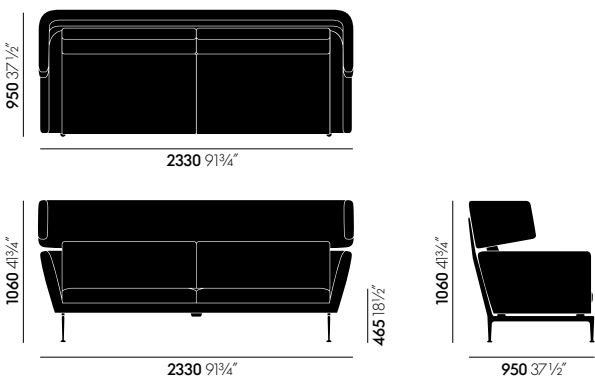

Suita Sofa Three-Seater with head section

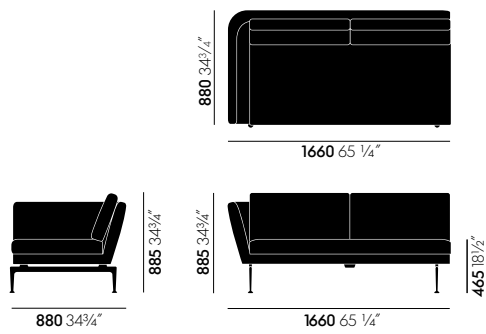

Suita Sofa Two-Seater open, armrest left

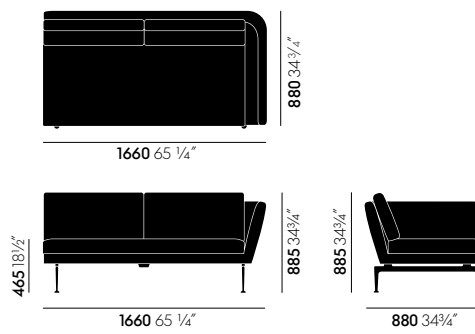

Suita Sofa Two-Seater open, armrest right

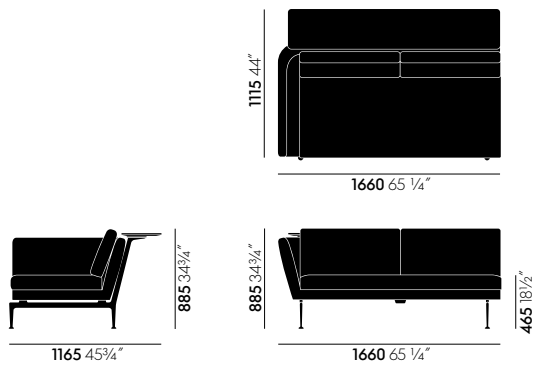

Suita Sofa Two-Seater open, armrest left, with shelf

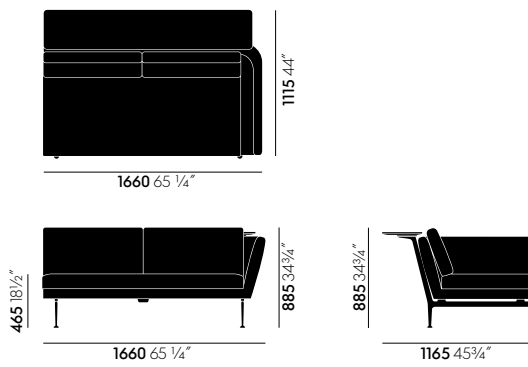

Suita Sofa Two-Seater open, armrest right, with shelf

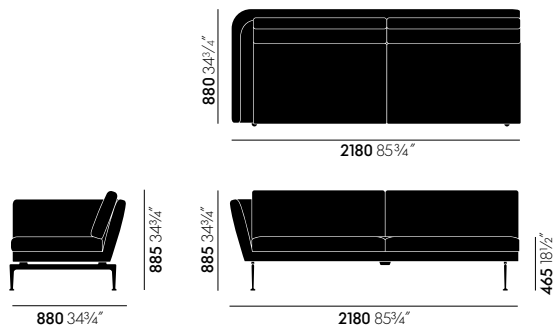

Suita Sofa Three-Seater open, armrest left

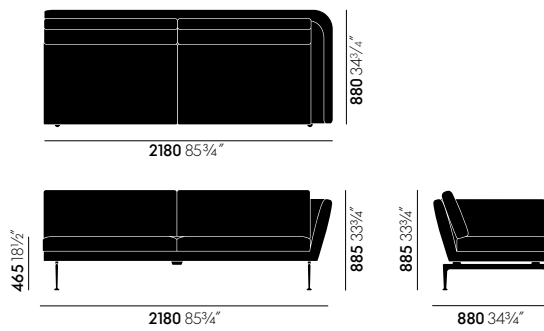

Suita Sofa Three-Seater open, armrest right

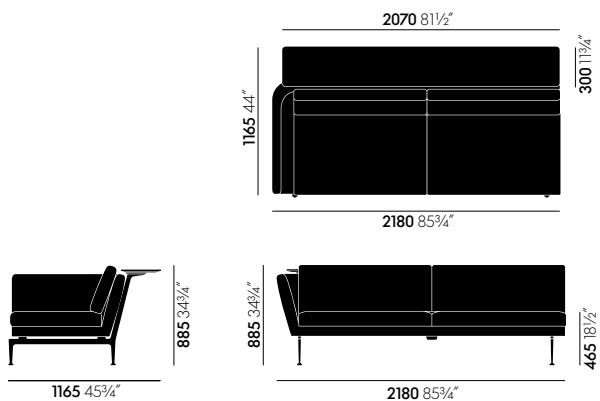

Suita Sofa Three-Seater open, armrest left, with shelf

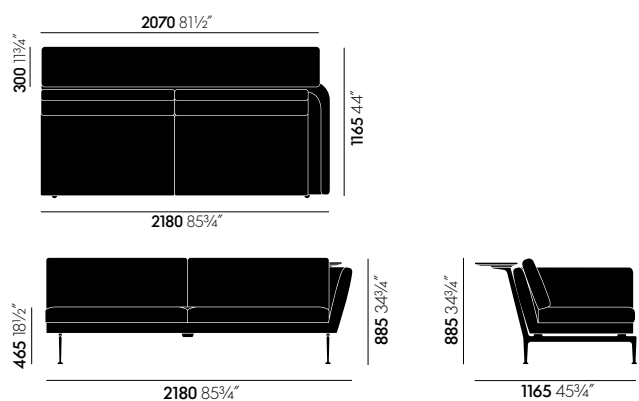

Suita Sofa Three-Seater open, armrest right, with shelf

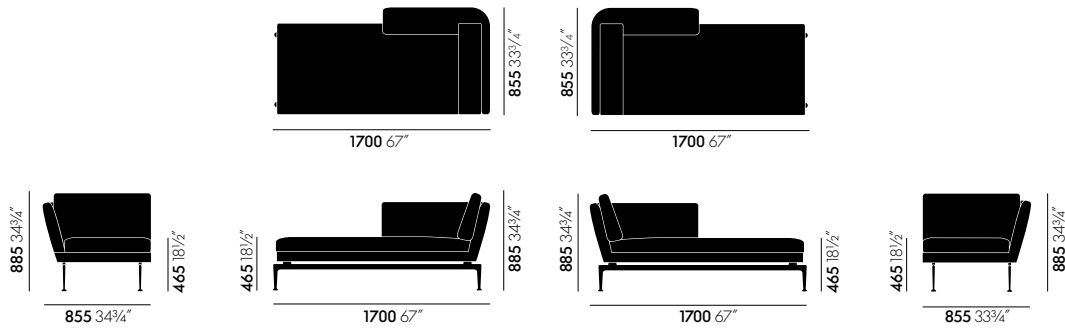

Suita Chaise Longue small, open left

Suita Chaise Longue small, open right

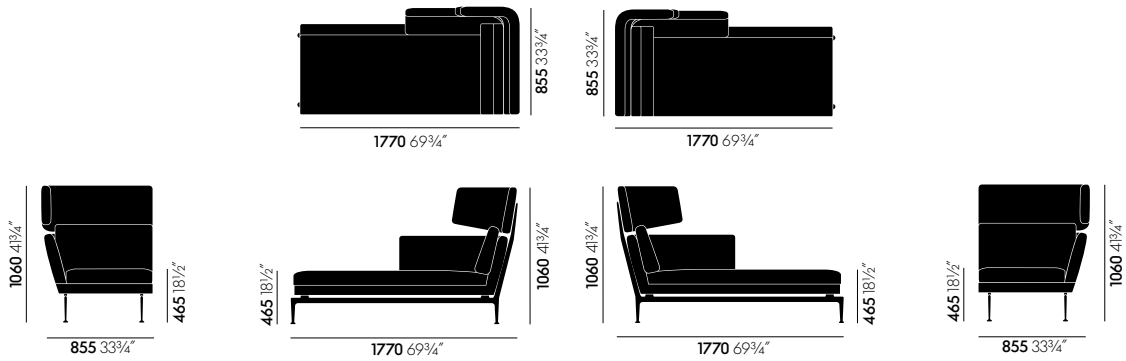

Suita Chaise Longue small, open left, with head section

Suita Chaise Longue small, open right, with head section

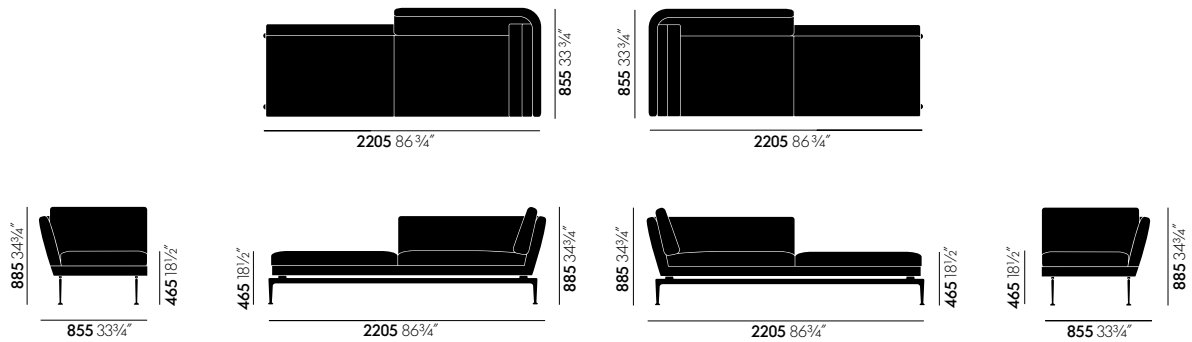

Suita Chaise Longue large, open left

Suita Chaise Longue large, open right

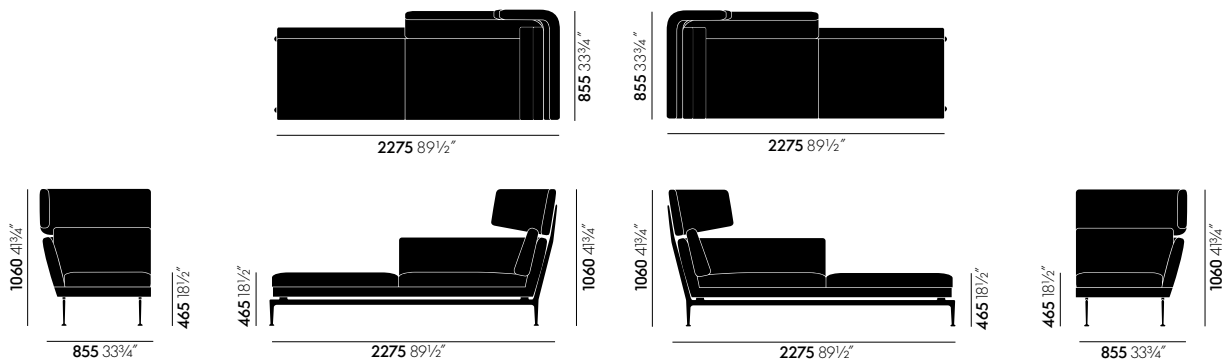

Suita Chaise Longue large, open left, with head section

Suita Chaise Longue large, open right, with head section

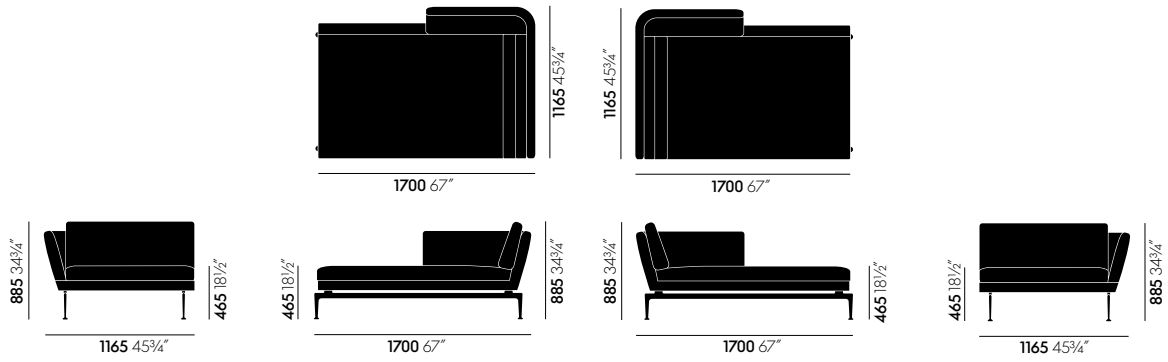

Suita Chaise Longue wide, open left

Suita Chaise Longue wide, open right

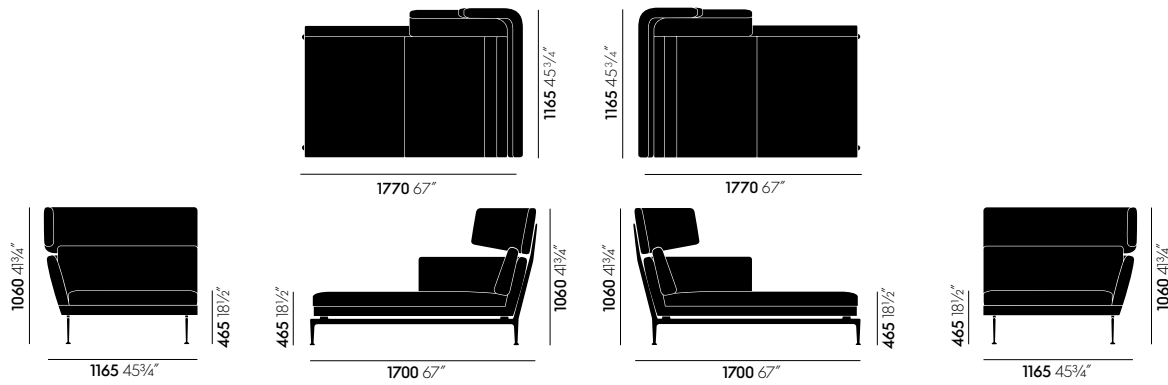

Suita Chaise Longue wide, open left, with head section

Suita Chaise Longue wide, open right, with head section

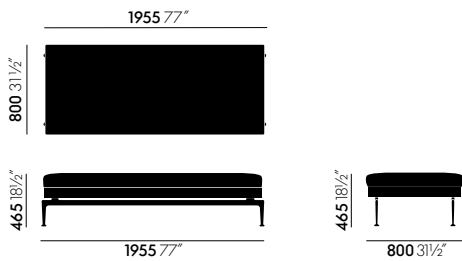

Suita Daybed

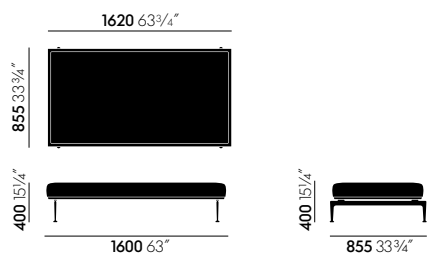

Suita Platform, 160 x 80 cm

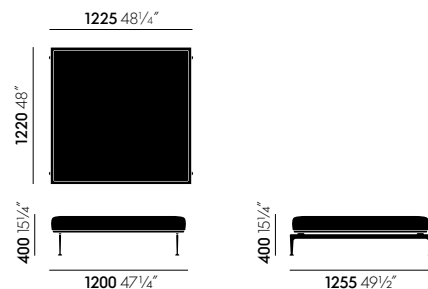

Suita Platform, 120 x 120 cm

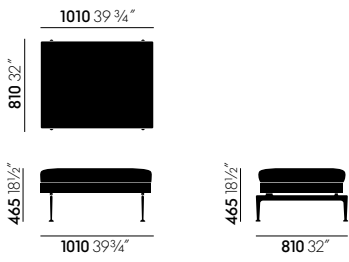

Suita Ottoman, 100 x 80 cm

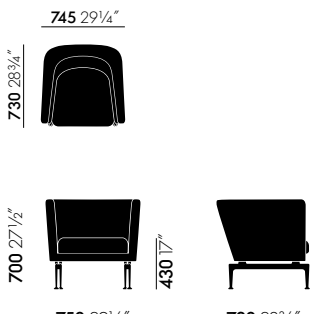

Suita Club Armchair

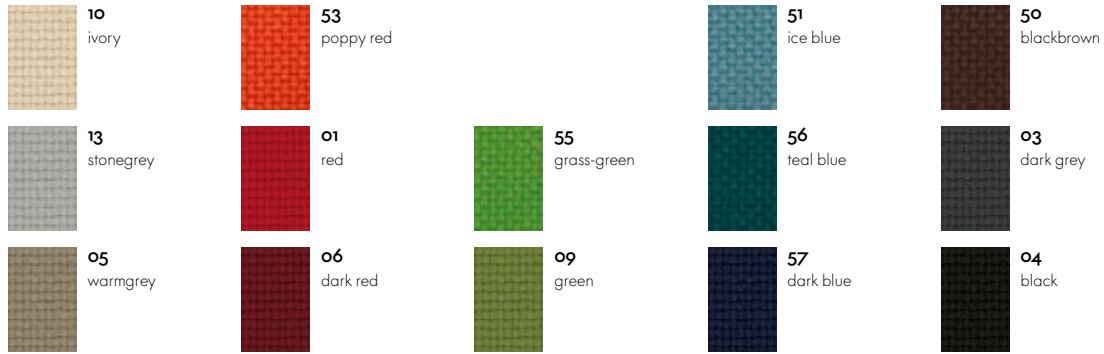

Laser



Cosy

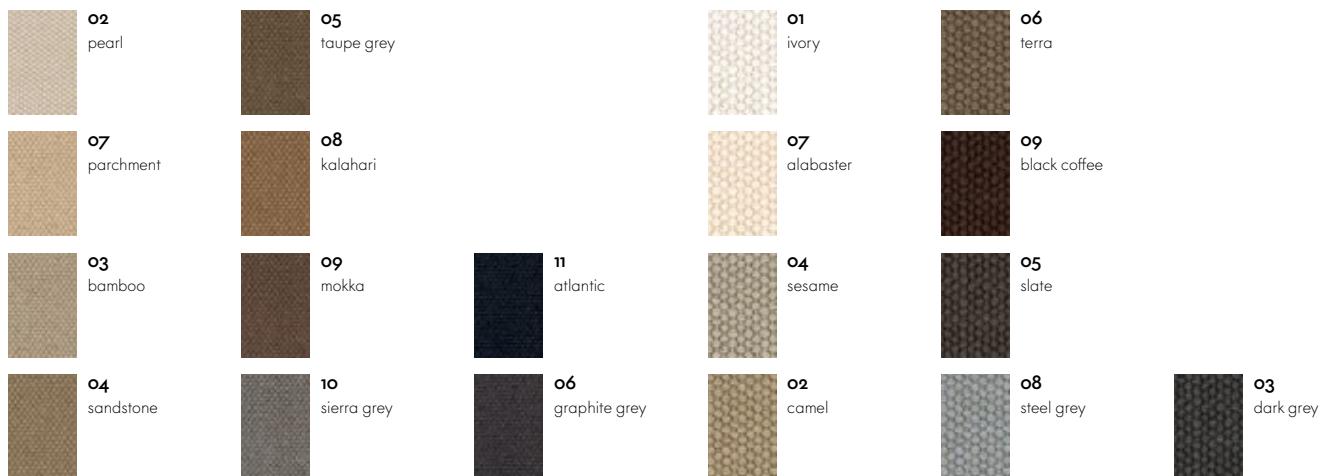

Olimpo

Over

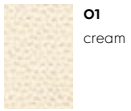

01
cream



14
sand/avocado

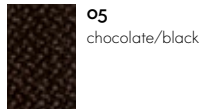

05
chocolate/black



06
sand melange



12
rock



15
safran



06
anthracite/
elephant



05
stone melange



11
cream/dolphin



16
red chilli

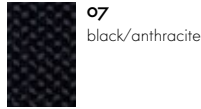

07
black/anthracite



01
pale blue
melange



02
dark brown
melange



13
salt 'n' pepper



17
black/aubergine



08
dark blue/ black



04
dark blue
melange



03
dark grey
melange

Credo

Corsaro

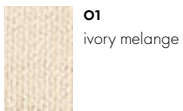

01
ivory melange



02
beige melange



07
ginger/grey



20
magenta
melange



08
anthracite
melange



03
beige/grey



17
sand melange

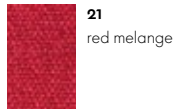

21
red melange



13
green melange



16
blue/grey



05
sand/anthracite



06
pebble melange



10
pale rose/beige



11
yellow melange



15
sage/pebble



09
grey melange



04
brown melange

Dumet

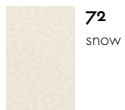

72
snow



71
sand



69
marron

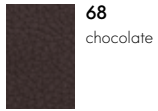

68
chocolate

Leather

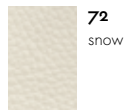

72
snow

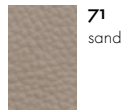

71
sand

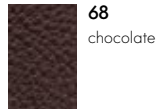

68
chocolate



77
brown

Leather Grand

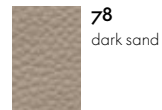

78
dark sand

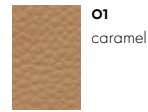

01
caramel

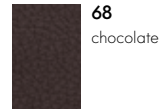

68
chocolate

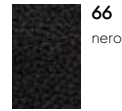

66
nero

Leather Natural

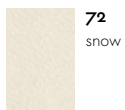

72
snow

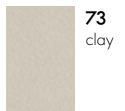

73
clay

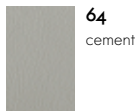

64
cement



71
sand

Leather Premium

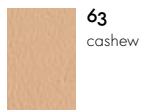

63
cashew



62
ochre

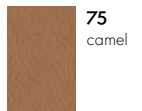

75
camel

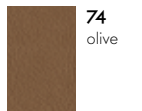

74
olive



97
cognac



22
red stone

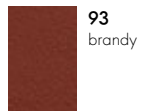

93
brandy

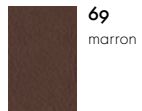

69
marron

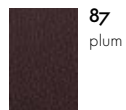

87
plum

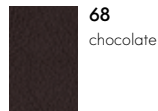

68
chocolate

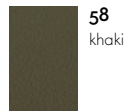

58
khaki

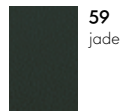

59
jade

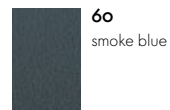

60
smoke blue



65
granite



61
umbra grey

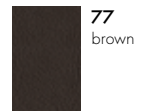

77
brown

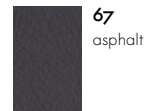

67
asphalt

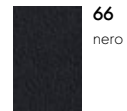

66
nero



30
basic dark



52
soft light

Tray



02
charcoal



03
peat

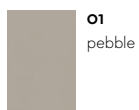

01
pebble

Linoleum
(tray-inlay)



52
soft light
powder-coated
(textured)



03
aluminium
polished

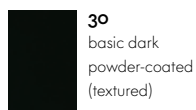

30
basic dark
powder-coated
(textured)

Base

