



**AXO<sup>®</sup>** 2011-2012  
LIGHT



# AURA

MANUEL VIVIAN

Collezione Aura con pendenti in vetro colorato incamiciato cristallo e ritorti a mano. Finiture a soffitto in acciaio lucidato o foglia oro. Colori vetri: bianco, rosso, nero, arancio, tè e cristallo "rigadin".

Aura collection with double-layered coloured glass hand twisted pendants. Ceiling plates in polished steel or gold leaf. Glass available in white, red, black, orange, tea and ribbed crystal.

Kollektion Aura mit farbigen und kristallumhüllten Glaspendeln, die von Hand gefertigt werden. Baldachin in Stahl oder Blattgold. Erhältliche Glasfarben; weiss, rot, schwarz, orange, teefarben und kristallklar mit Reliefstreifen.

Collection Aura avec des suspentes en verre coloré chemisé cristal et formés à la main. Finition acier chromé ou or vieilli à la feuille. Couleurs verreries: blanc, rouge, orange, noir, thé et cristal avec relief.

Collección Aura con lagrimas en cristal de color soplado y retorcido a mano. Acabado del plafón en acero o dorado. Color del cristal: blanco, rojo, negro, naranja, te y cristal "rigadin".

Коллекция Aura с подвесками из цветного стекла, с прозрачной стеклянной облицовкой. Скрученные подвески ручной работы. Опоры светильников из глянцевой стали или покрыты золотой фольгой. Коллекция предлагается в следующей цветовой гамме: белый, красный, чёрный, оранжевый, чайный и муранское стекло "rigadin".

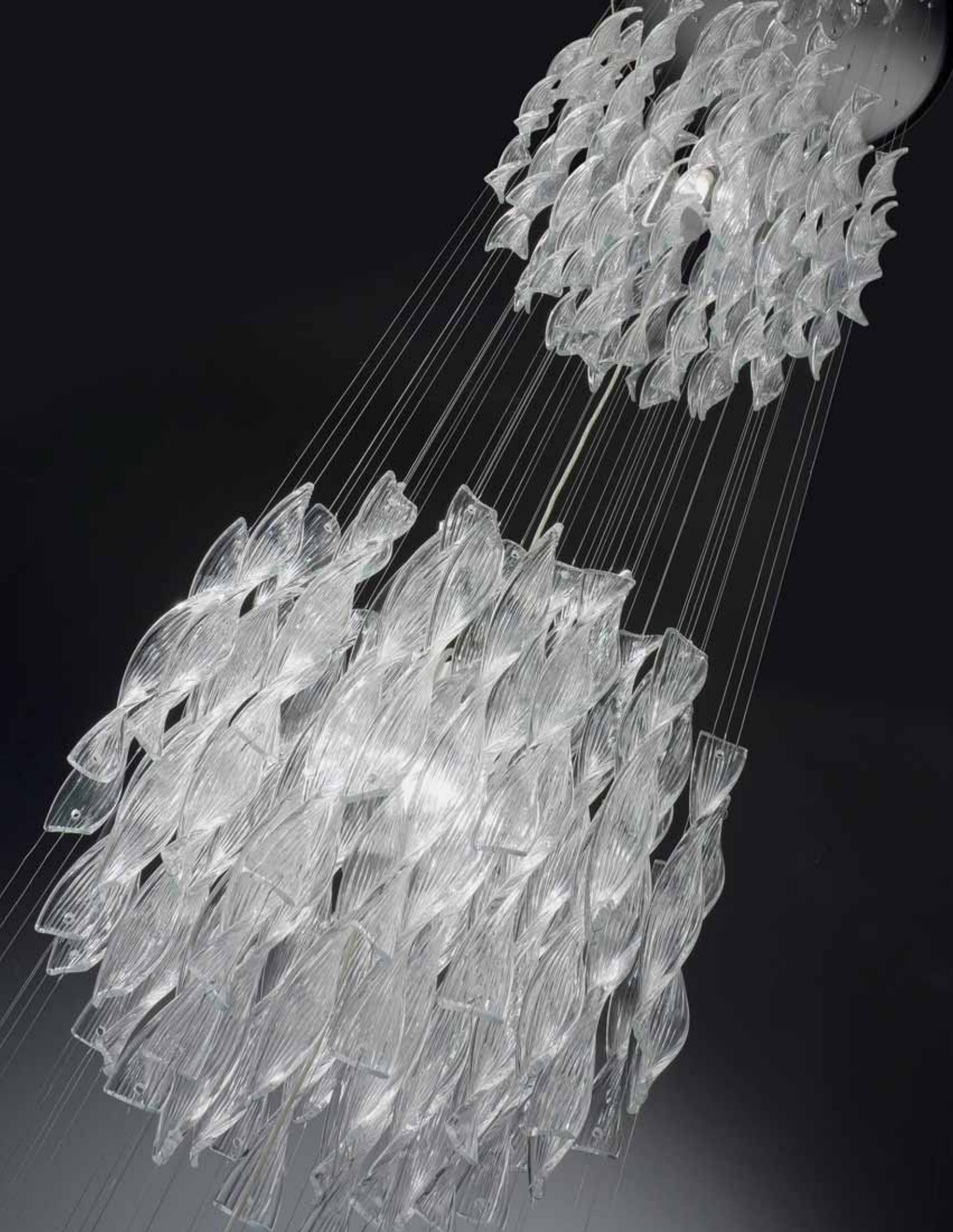





^ PL AUR G 30  
< PL AURA GR  
< AURA GLASS DETAIL  
« PG 131: SP AU 60/3





< AP AURA / PL AURA GR



SP AURA 60  
COLORI: NERO / ARANCIO / TÈ  
BIANCO / CRISTALLO / ROSSO  
COLOURS: BLACK / ORANGE / TEA  
WHITE / CRYSTAL / RED

































^ FA AURA 44  
< SP AU 60/2



TECHNICAL DATA





-  E27 incandescent
-  E14 incandescent
-  E14 incandescent
-  E27 fluorescent
-  E27 fluorescent globe
-  E27 fluorescent twist
-  E14 fluorescent
-  E14 fluorescent
-  E14 fluorescent
-  E27 fluorescent
-  GX24q-2 fluorescent
-  2GX13 fluorescent
-  2G11 fluorescent
-  G5 fluorescent
-  G24d-2 fluorescent
-  G9 halogen
-  E27 halogen
-  G4 halogen
-  GY 6.35 halogen
-  GU4 halogen
-  GU5.3 halogen
-  GU10 halogen
-  E14 halogen
-  G53 halogen
-  R7s halogen

I nostri prodotti sono tutti sottoposti alle prove di sicurezza elettrica e conformi alle Direttive Comunitarie Europee EN60598-1, LVD 2006/95/EC, EMC 2004/108/EC (ove previsto).

All our products undergo electric safety tests and comply with ECC Directive EN60598-1, LVD 2006/95/EC, EMC 2004/108/EC (where provided).

Entsprechend den Europäischen Normen EN60598-1, LVD 2006/95/EC, EMC 2004/108/EC (sofern vorgesehen), werden alle Produkte den elektrischen Sicherheitsprüfungen unterzogen.

Tous nos produits sont soumis aux tests de sécurité, et sont conformes aux Directives CEE EN60598-1, LVD 2006/95/EC, EMC 2004/108/EC (le cas échéant).

Todos nuestros productos han sido sometidos a las pruebas de seguridad eléctrica y son conformes con las directivas comunitarias europeas EN60598-1, LVD 2006/95/EC, EMC 2004/108/EC (en los casos previstos).

Все наши изделия проходят испытания на электрическую безопасность и соответствуют директивам Европейского Сообщества EN60598-1, LVD 2006/95/EC, EMC 2004/108/EC (в случаях, когда это предусмотрено).



Solo isolamento fondamentale; le parti conduttrici accessibili sono collegate ad un conduttore di terra. Messa a terra obbligatoria.

Basic insulation, accessible conductors are earthed. Earthing is compulsory.

Grundisolation: berührbare Metallteile mit Anschlussstelle für Schutzleiter verbunden. Netzschutzleiter: vorgeschrieben.

Isolation de base: les parties conductrices accessibles sont mises à terre. Mise à terre obligatoire.

Solo aislamiento fundamental; las partes conductoras accesibles están conectadas a un conductor de tierra. Puesta a tierra obligatoria.

Изоляция только базовая. Доступные проводниковые части подсоединены к заземлителю. Заземление обязательно.



Sistema a doppio isolamento;  
messa a terra esclusa.

Double insulation. Earthing:  
excluded.

Doppelte Isolierung.  
Netzschutzleiter: nicht erlaubt.

Double isolation. Mise à la terre:  
exclue.

Sistema de doble aislamiento;  
puesta a tierra no incluida.

Система двойной изоляции.  
Заземление необязательно.



Apparecchio in cui la protezione  
contro la scossa elettrica si basa  
sulla alimentazione a bassissima  
tensione di sicurezza.

Appliance in which protection  
against electrical shock is  
guaranteed by the extremely  
low-voltage power supply.

Zum Schutz vor elektrischen  
Schlägen mit Niedervolt Gespeistes  
Gerät.

Appareil avec protection contre  
les décharges électriques basée  
sur l'alimentation à une tension  
de sécurité très basse.

Aparado en el qual la protecció  
contra la descarga eléctrica se debe  
a la alimentació a muy baja  
tensió.

Прибор, в котором защита от удара  
током основана на питании от  
очень низкого напряжения.



Predisposto con variatore di luce.

With dimmer.

Mit Dimmer.

Avec dimmer.

Con dimmer.

Предусмотрено с диммер.

Le schede tecniche dei prodotti  
Axo Light sono scaricabili  
direttamente dal nostro sito.

Axo Light technical sheets  
can be directly downloaded from  
our website.



Les fiches techniques des produits  
Axo Light peuvent être téléchargés  
directement de notre site.

Las fichas técnicas de producto  
Axo Light se pueden descargar  
directamente de nuestro sitio.

Die Axo Light Produktdatenblätter  
können direkt von unserer Website  
heruntergeladen werden.

Технические характеристики  
изделий фирмы Axo Light  
возможно скачать с нашего сайта.



**FA ARI P**

base / bulb type GU5.3 halogen  
 power 1 x max 35 w  
 ilcos HAGS/UB   
 marks  12V 

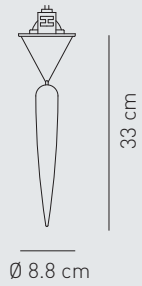
hole Ø 6.5 cm / min depth 10 cm





**FA ARI G**

base / bulb type GU5.3 halogen  
 power 1 x max 35 w  
 ilcos HAGS/UB   
 marks  12V 

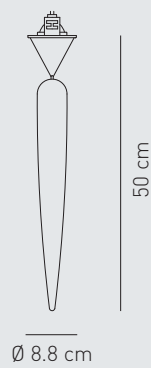
hole Ø 6.5 cm / min depth 10 cm





**FA AURA 30**

base / bulb type GU5.3 halogen  
 power 1 x max 35 w  
 ilcos HAGS/UB   
 marks  12V 

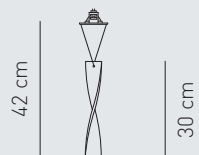
hole Ø 6.5 cm / min depth 10 cm





**FA AURA 44**

base / bulb type GU5.3 halogen  
 power 1 x max 35 w  
 ilcos HAGS/UB   
 marks  12V 

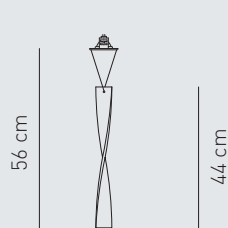
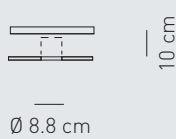
hole Ø 6.5 cm / min depth 10 cm



**FA AURA 53**

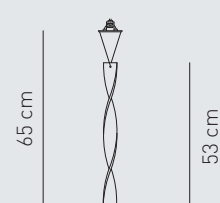
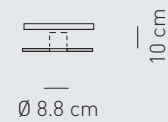

base / bulb type GU5.3 halogen  
 power 1 x max 35 w  
 ilcos HAGS/UB   
 marks  12V 

hole Ø 6.5 cm / min depth 10 cm







### FA AURA 60

base / bulb type GU5.3 halogen  
power 1 x max 35 w  
ilcos HAGS/UB   
marks **CE** 12V 

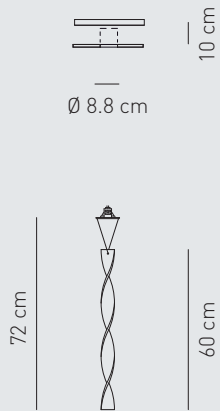
hole  $\varnothing$  6.5 cm / min depth 10 cm



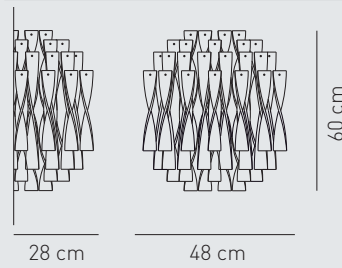

### AP AURA

base / bulb type E27 incandescent  
or E27 halogen  
power 2 x max 100 w  
ilcos IAA/C or HSGST/C/UB   
marks **CE** 



### PL AUR P 30

base / bulb type E27 halogen  
power 4 x max 100 w  
ilcos HSGST/C/UB   
marks **CE** 

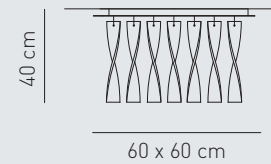



polished steel  
finishings



gold leaf  
finishings



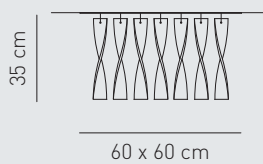

### PL AU P 30 I

base / bulb type E27 halogen  
power 4 x max 100 w  
ilcos HSGST/C/UB   
marks **CE** 



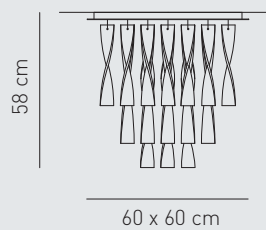

### PL AURA P

base / bulb type E27 halogen  
power 4 x max 100 w  
ilcos HSGST/C/UB   
marks **CE** 



### PL AURA P I

base / bulb type E27 halogen  
power 4 x max 100 w  
ilcos HSGST/C/UB   
marks **CE** 

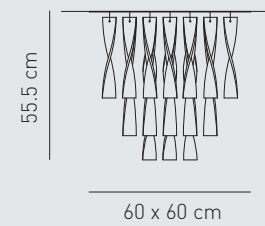

### PL AUR G 30

base / bulb type E27 halogen  
power 4 x max 100 w  
ilcos HSGST/C/UB   
marks CE ⊕

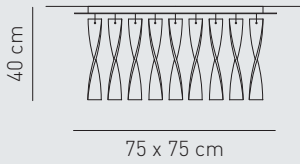

### PL AUR G 30 I

base / bulb type E27 halogen  
power 4 x max 100 w  
ilcos HSGST/C/UB   
marks CE ⊕

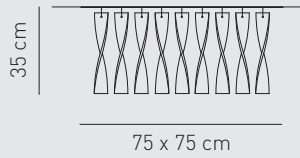

### PL AURA GR

base / bulb type E27 halogen  
power 4 x max 100 w  
ilcos HSGST/C/UB   
marks CE ⊕

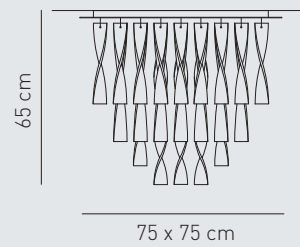

### PL AURA G I

base / bulb type E27 halogen  
power 4 x max 100 w  
ilcos HSGST/C/UB   
marks CE ⊕

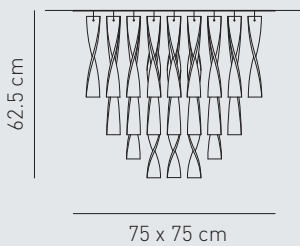

### PL AURA 45

base / bulb type E27 halogen  
power 1 x max 150 w  
ilcos HSGST/C/UB   
marks CE ⊕

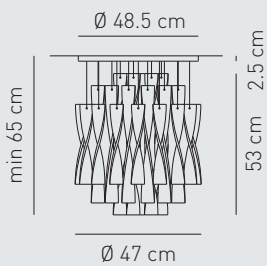

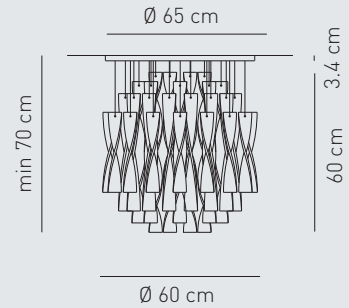

### PL AURA 60

base / bulb type E27 halogen  
power 1 x max 250 w  
ilcos HSGST/C/UB   
marks CE ⊕



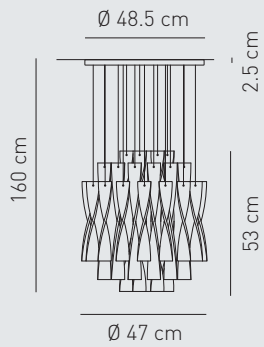

### SP AURA 45

base / bulb type E27 halogen  
power 1 x max 150 w  
ilcos HSGST/C/UB   
marks CE 



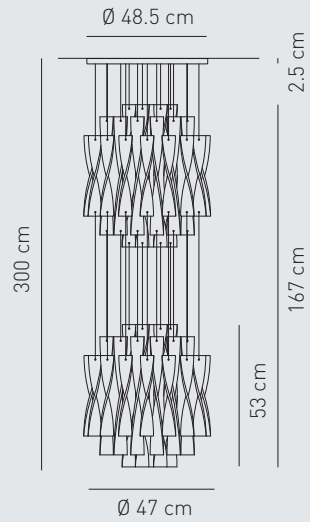

### SP AU 45/2

base / bulb type E27 halogen  
power 2 x max 150 w  
ilcos HSGST/C/UB   
marks CE 



### SP AURA 60

base / bulb type E27 halogen  
power 1 x max 250 w  
ilcos HSGST/C/UB   
marks CE 

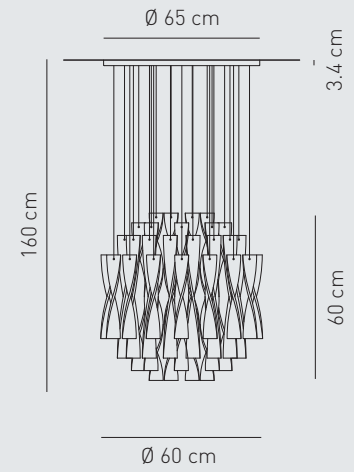

**SP AU 60/2**

base / bulb type E27 halogen  
 power 2 x max 250 w  
 ilcos HSGST/C/UB   
 marks CE ⊕

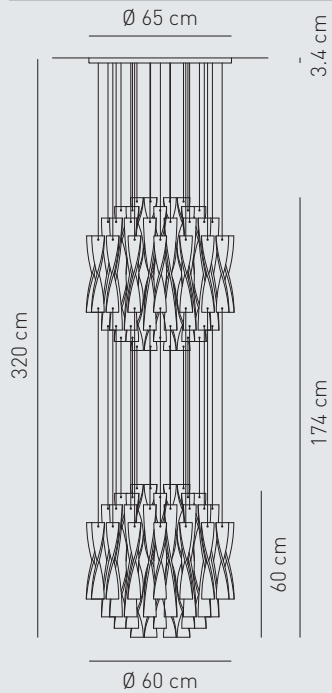

**AX20** CHROME-PLATED FINISHINGS

**AP AX20 PI**

base / bulb type G9 halogen  
 power 1 x max 60 w  
 ilcos HSGST/C/UB   
 marks CE ⊕

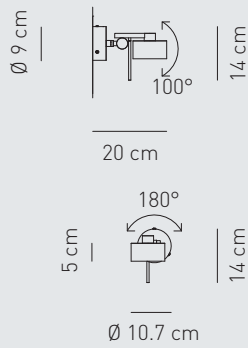

**AP AX20 GR**

base / bulb type G9 halogen  
 power 1 x max 60 w  
 ilcos HSGST/C/UB   
 marks CE ⊕

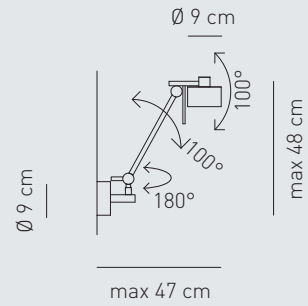

**SP AX20 PI**

base / bulb type G9 halogen  
 power 1 x max 60 w  
 ilcos HSGST/C/UB   
 marks CE ⊕

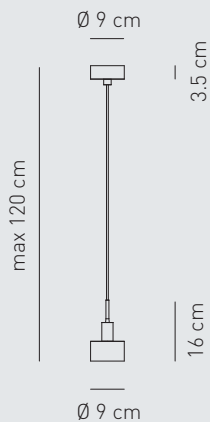

**SP AX20 DE**

base / bulb type G9 halogen  
 power 1 x max 60 w  
 ilcos HSGST/C/UB   
 marks CE ⊕

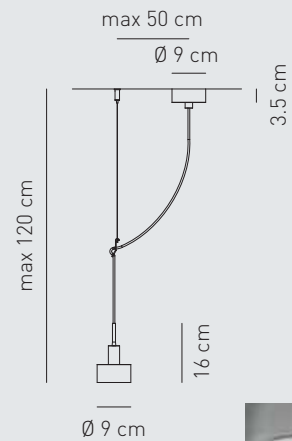



Axo Light si riserva il diritto di apportare ai modelli, senza alcun preavviso, qualsiasi modifica ritenesse opportuna. Axo Light non risponde per eventuali danni a persone o cose causati da una non corretta installazione dei propri apparecchi d'illuminazione.

I dati riportati sono puramente indicativi; è possibile che siano riportati degli errori di stampa.

Axo Light reserves itself the right to introduce any changes to its own models, without prior notice. Axo Light is not liable for injuries or damage due to the incorrect installation of its fixtures. The details given here are intended purely as guidance as errors may have occurred during the printing process.

Axo Light behält sich das Recht vor, jederzeit und ohne Voranmeldung, Änderungen der Kollektion vorzunehmen, ohne jedoch die charakteristischen Eigenschaften der Artikel zu ändern. Axo Light ist nicht verantwortlich für eventuelle Personen- oder Sachschäden, verursacht durch unsachgemäße Installation der Produkte. Aufgrund möglicher Druckfehler, sind die angegebenen Daten lediglich als Richtwerte zu verstehen.

Axo Light se réserve le droit de modifier ses collections à tous moments et sans préavis, dans le respect des caractéristiques de base du produit. Axo Light ne répond pas aux éventuels dommages à personnes ou choses causés par une mauvaise installation de ses appareils d'éclairage. Les coordonnées mentionnées sont purement indicatives; il est possible que des erreurs d'impression y figurent.

Axo Light se reserva el derecho de aportar a los propios modelos, sin ningún preaviso, cualquier modificación que se considere oportuna. Axo Light no responde por los eventuales daños causados a personas o cosas provocados por una incorrecta instalación de los propios aparatos de iluminación. Los datos que aparecen son puramente indicativos; es posible que contengan errores de impresión.

Ахо Light оставляет за собой право вносить модификации моделей без предупреждения, в случае необходимости. Ахо Light не несёт ответственности за ущерб людям или вещам, вызванный некорректной установкой осветительных приборов. Приведенные данные носят иллюстративный характер; возможны опечатки.